

展示璀璨

演繹光華

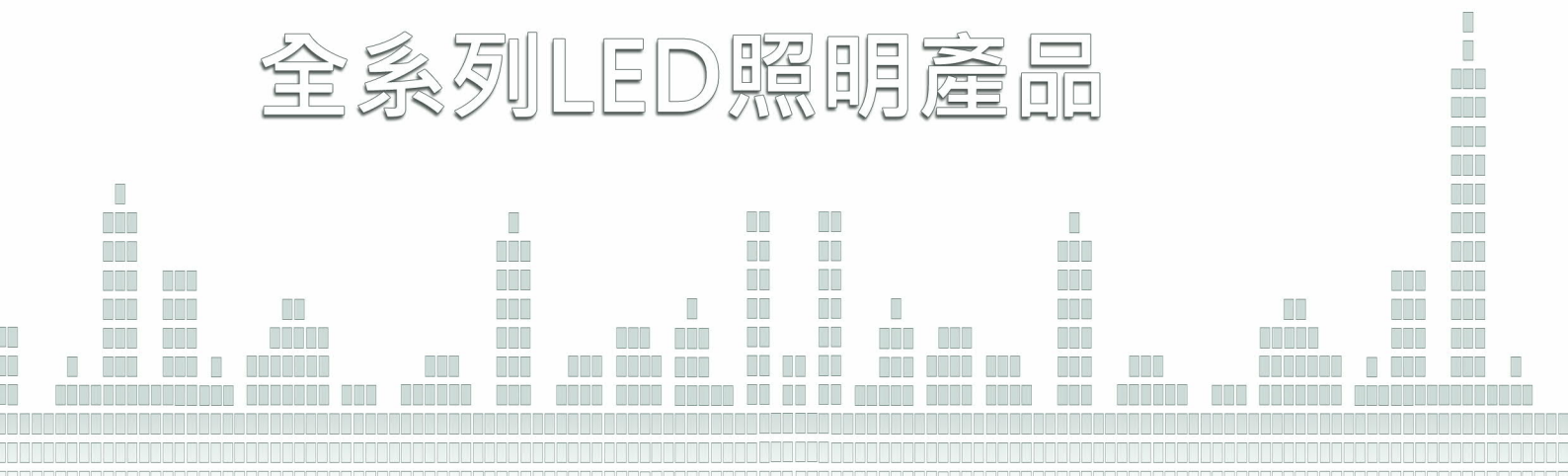

全系列LED照明產品



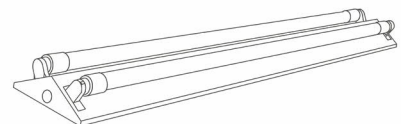
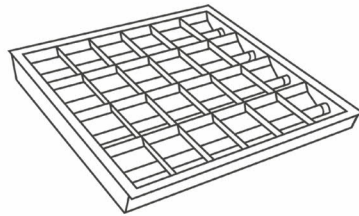
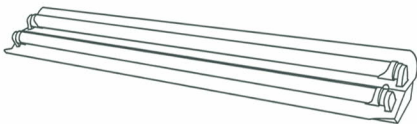
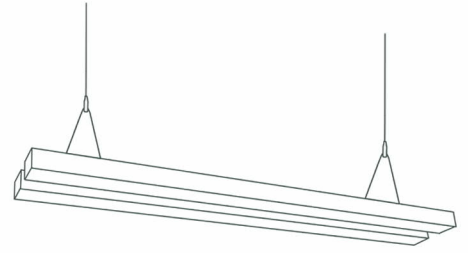
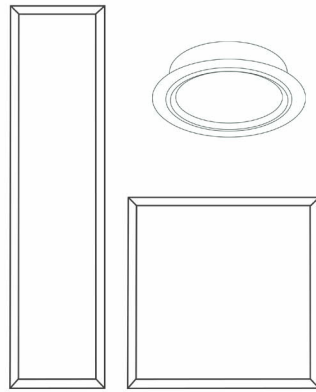
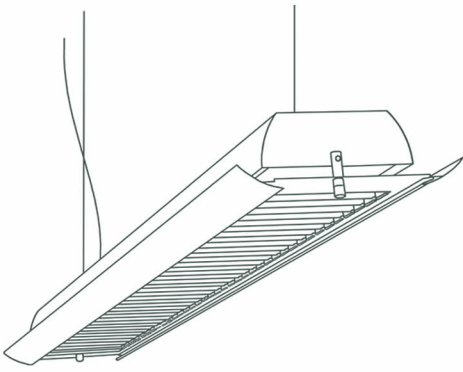

中輝光電股份有限公司

新北市五股區五權路 71 號 3 樓
(力揚大樓 / 新北產業園區)

Tel: (02) 8990-1566 Fax: (02) 8990-2566

E-mail: service@rastar.com.tw

網址: <http://www.winstartek.com>

RADIANT STAR CO., LTD.

3F., 71, Wuquan Road, Wugu District, New Taipei City, Taiwan
(New Taipei Industrial Park)

Tel: 886-2-89901566 Fax: 886-2-89902566

E-mail: service@rastar.com.tw

Web Site: <http://www.winstartek.com>

目錄 CONTENTS

頁次 PAGE NO.	內容 CONTENTS
01 - 02	LED 平板燈 LED FLAT PANEL LAMP
03 - 05	LED 映彩燈 COLOR PRINTING LAMP
06 - 20	LED 吊燈-鋁擠型 LED PENDANT LAMP - ALUMINUM EXTRUDED TYPE
21	LED 吊燈 LED PENDANT LAMP
22 - 23	LED 教室燈與黑板燈 LED CLASSROOM LAMP AND LED BLACK BOARD LAMP
24 - 25	LED 系統吊燈與圓環燈 LED SYSTEM PENDANT LAMP AND CIRCLE LAMP
26	LED 不斷光串接燈 LED CONNECTIBLE LAMP
27	LED 三色燈 LED VARIABLE COLORS LAMP
28	LED 嵌燈 LED RECESSED LAMP
29	LED 嵌燈-防水鹽型 LED RECESSED LAMP - WATER+SALT PROOF TYPE
30	LED 投射燈 / MR16 / AR70 LED SPOT LAMP / AR70
31	LED AR111 LED AR111 LAMP
32	LED 盒燈 LED BOX LAMP
33 - 34	LED 吸頂燈 LED CEILING MOUNTED LAMP
35	LED 吸頂燈-智能型 LED CEILING MOUNTED LAMP – INTELLIGENT TYPE
36 - 40	LED 軌道燈 LED TRACK LAMP
41	LED 碗形燈 LED BOWL SHAPE LAMP
42	櫥櫃燈 CABINET LAMP
43	LED 投光燈 LED FLOOD LAMP
44	LED 天井燈-飛碟燈 LED HIGH BAY LIGHT – UFO LAMP
45	LED 投光天井燈 LED FLOOD HIGH BAY LIGHT
46	LED 投光天井燈-防水鹽型 LED FLOOD HIGH BAY LIGHT – WATER+SALT PROOF TYPE
47	潔淨室照明 CLEAN ROOM LAMP
48	LED 自動感應燈 LED AUTO SENSE LAMP
49	LED 防水燈(三防燈) LED WATER PROOF LAMP
50	LED 筒燈 LED DOWNLIGHT LAMP
51	T8 LED 燈管 T8 LED TUBE
52	輕鋼架燈 T-BAR LAMP
53	LED 山型吸頂燈 LED CEILING MOUNTED LAMP
54	LED 工事燈 LED ENGINEERING LAMP
55	燈具配件 LIGHTING ACCESSORIES
56 - 57	紫外線殺菌器 UVC GERMICIDER
58	LED 一體線型燈 LED LINEAR LAMP
59	LED 軟條燈 LED SOFT STRIP LIGHT
60 - 61	燈光設計 照明規劃 LIGHTING DESIGN AND PLANNING

符合 CNS 國家標準與節能標章規範

Comply with CNS National Standards and Energylabel Regulations



最高效率、最省電的燈具

Highest efficiency, most energy-saving lamp



產品型號 Model No.	ZH-22DL57-25W	ZH-22DL57-21W
功率 Wattage	25W	21W
輸入電壓 Input Voltage	AC 100V-240V	AC 100V-240V
頻率 Frequency	50/60Hz	50/60Hz
光通量 Luminous Flux	3,600 lm (typ.)	3,500 lm (typ.)
發光效率 Luminous Efficiency	140 lm/W (typ.)	160 lm/W (typ.)
燈光色溫 Color Temperature	5700K	5700K
演色性 Color Rendering Index	> 80	> 80
LED 壽命 LED Life (L70)	40,000 Hr	40,000 Hr
1 米照度 1 Meter Illuminance	1,088 Lux	1,060 Lux
光束角度 Beam Angle	115 Degree	115 Degree
材質 Material	金屬烤漆 Metal Coating	金屬烤漆 Metal Coating
燈具尺寸 Lamp Size (LxWxH)	600x600x30 mm	600x600x30 mm
重量(不含驅動) Weight (Without Driver)	2 kg	2 kg

護眼 LED 平板燈

潔淨的光源
省電又環保

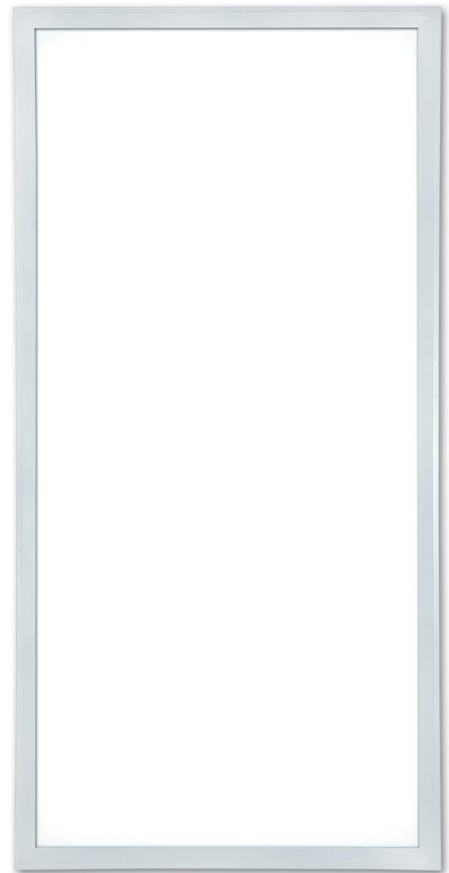
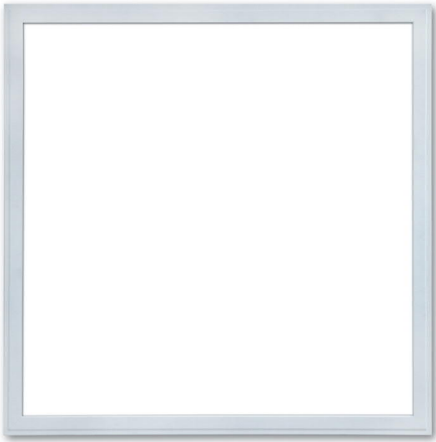

- ✧ 直發光型(直下式)。
- ✧ 燈光高亮柔和，無眩光與疊影。
- ✧ 無紫外線與紅外線輻射。
- ✧ 薄型化燈具，屋頂天花板可升高，減少壓迫感。
- ✧ 節省能源，使用壽命長。
- ✧ 容易安裝，容易清潔。
- ✧ 可搭配智能照明控制系統使用。
- ✧ Direct-lit type.
- ✧ The light is bright and soft, no glare and shadows.
- ✧ No UV and IR radiation.
- ✧ Thin luminaires, roof ceilings can be raised to reduce pressure.
- ✧ Save energy. Long lifetime.
- ✧ Easy to install, easy to clean.
- ✧ Can be used with smart lighting system.



WIFI / APP 遙控 本燈可加裝 智能調控裝置

型號 Model No.	型式 Type	燈光色溫 Color Temp.	功率 Wattage	輸入電壓 Input Voltage	主體尺寸 Size (mm)		
					長(L)	寬(W)	高(H)
ZH-PA22DL30L-N32	直下式 Direct-lit	3000K	32W	110V/220V	600	600	30
ZH-PA22DL40L-N32	直下式 Direct-lit	4000K	32W	110V/220V	600	600	30
ZH-PA22DL57L-N32	直下式 Direct-lit	5700K	32W	110V/220V	600	600	30
ZH-14DL40-32W	直下式 Direct-lit	4000K	32W	110V/220V	1200	300	32
ZH-14DL57-32W	直下式 Direct-lit	5700K	32W	110V/220V	1200	300	32
ZH-24DL40-32W	直下式 Direct-lit	4000K	32W	110V/220V	1200	600	32
ZH-24DL57-32W	直下式 Direct-lit	5700K	32W	110V/220V	1200	600	32

LED 映彩燈

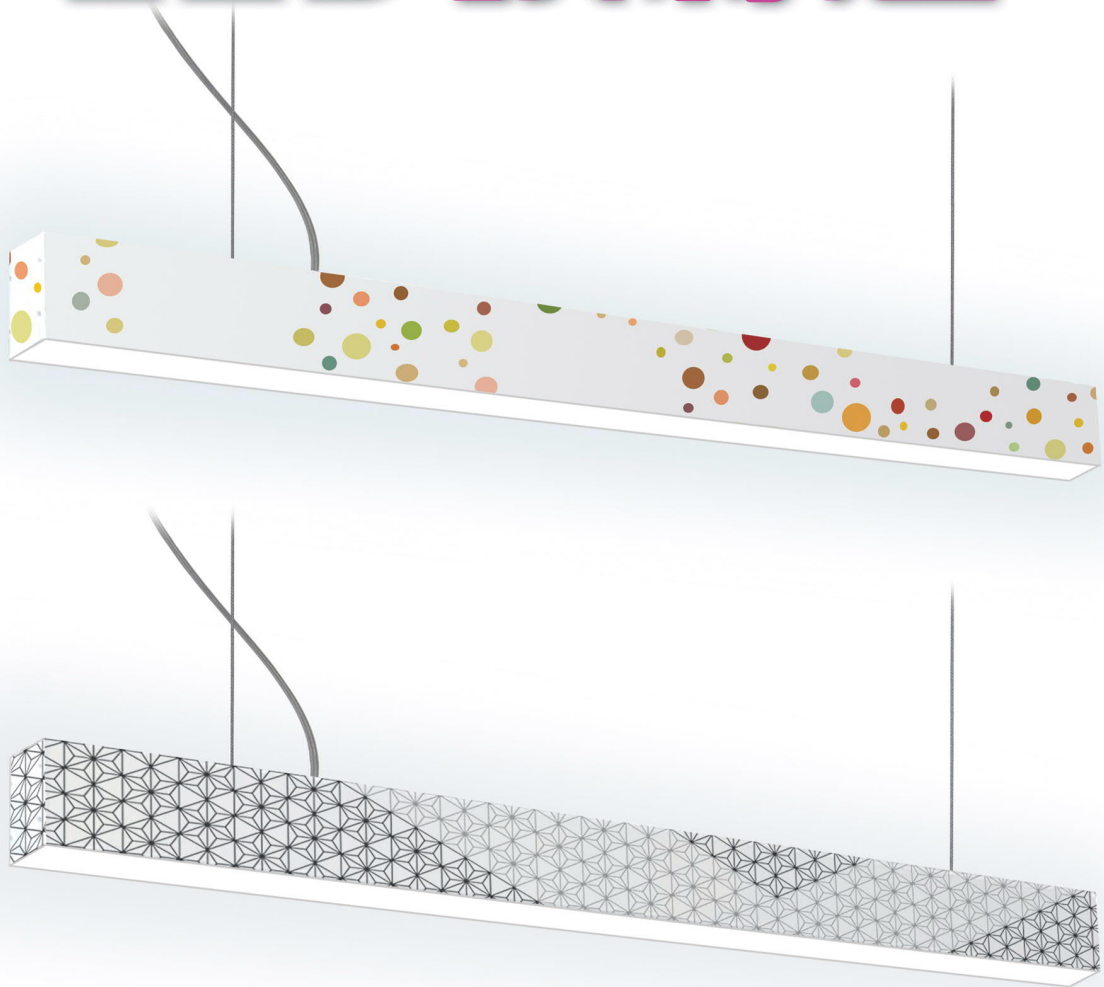

調和空間的色彩

展現空間的風格



獨一無二 客製圖樣

風華 現代 古典 禪意

讓燈具展現 你喜歡的樣子



參考圖樣:

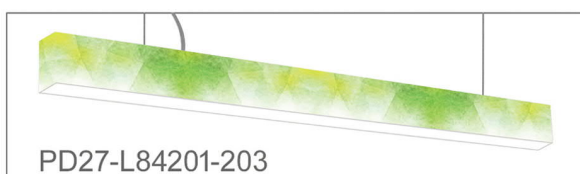
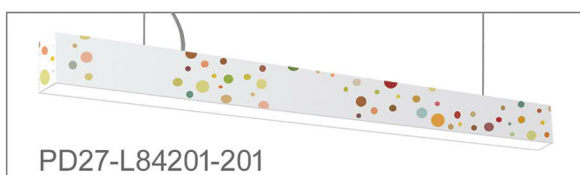
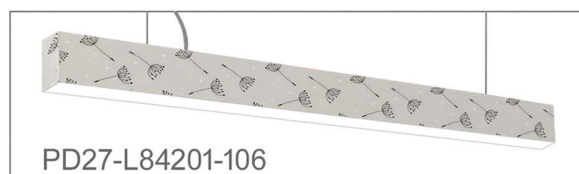
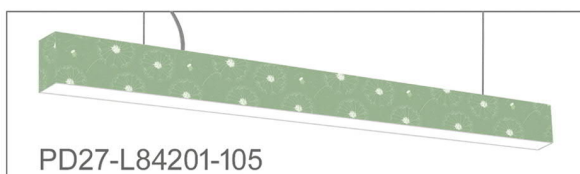
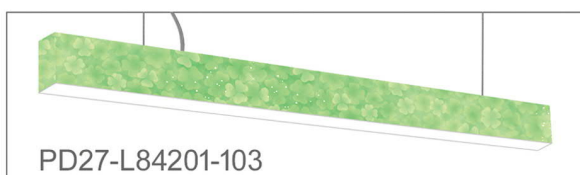
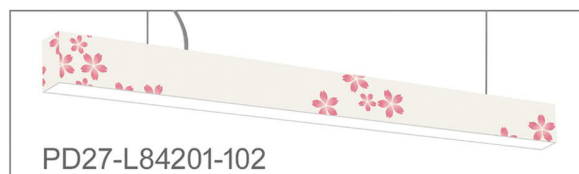



規格

燈具材質：鋁擠

燈具尺寸(mm)：1236(長) x 70(寬) x 100(高) (不含吊線與線扣)

光源：LED，20W，110V-220V

產地：台灣

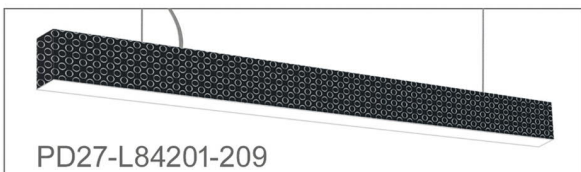
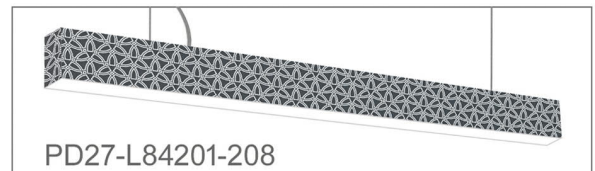
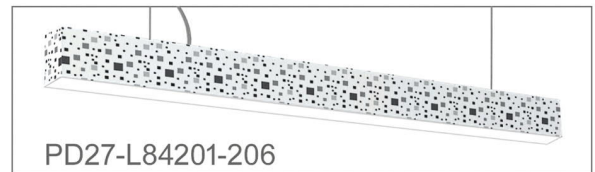
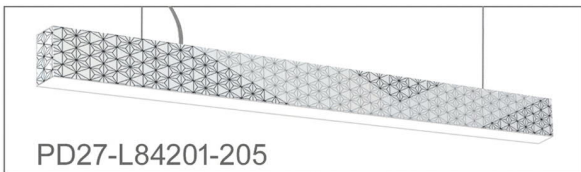

款式與規格多種

接受 OEM 自行提供圖樣訂製

歡迎洽詢



吸頂型 Mounted Type
型號 Model No. : MT-M



吊掛型 Pendant Type
型號 Model No. : PD29-1



WiFi / APP 遙控

本燈可加裝
智能調控裝置



台製配件

Accessories made in Taiwan

- ◇ 最微型的 T8 吸頂燈。
- ◇ 使用光源：LED T8 燈管、LED T5 燈管、T5 日光燈管。
- ◇ 全鋁燈殼，重量輕，質感佳，散熱效果良好。
- ◇ 可裝置於天花板輕鋼架的框架(龍骨)上。
- ◇ 可供作吊燈。
- ◇ 可選用飛利浦 T5 LED 燈管。

- ◇ Being a micro type T8 ceiling mounted lamp.
- ◇ Light source: LED T8 Tube, LED T5 Tube, T5 Fluorescent Tube.
- ◇ Aluminum lamp housing, light weight, exquisite appearance, good heat radiation effect.
- ◇ Can be installed on a frame of T-bar ceiling.
- ◇ Available to be a pendant lamp.
- ◇ Philips T5 LED Tube is available for option.

型號 Model No.	燈具種類 Lamp Type	光源 Light Source	功率 Wattage	輸入電壓 Voltage	主體尺寸 Size (mm)		
					長(L)	寬(W)	高(H)
MT-M-L82101	吸頂型 Mounted Type	T8 LED 燈管 T8 LED Tube	10W x 1	110-220V	615	66	46
MT-M-L84201	吸頂型 Mounted Type	T8 LED 燈管 T8 LED Tube	20W x 1	110-220V	1236	66	46
MT-M-L52081	吸頂型 Mounted Type	T5 LED 燈管 T5 LED Tube	8W x 1	110-220V	585	66	46
MT-M-L54161	吸頂型 Mounted Type	T5 LED 燈管 T5 LED Tube	16W x 1	110-220V	1185	66	46
MT-M-141	吸頂型 Mounted Type	T5 日光燈管 T5Fluorescent Tube	14W x 1	110-220V	585	66	46
MT-M-281	吸頂型 Mounted Type	T5 日光燈管 T5Fluorescent Tube	28W x 1	110-220V	1185	66	46
PD29-1-L82101	吊掛型 Pendant Type	T8 LED 燈管 T8 LED Tube	10W x 1	110-220V	615	66	46
PD29-1-L84201	吊掛型 Pendant Type	T8 LED 燈管 T8 LED Tube	20W x 1	110-220V	1236	66	46
PD29-1-L52081	吊掛型 Pendant Type	T5 LED 燈管 T5 LED Tube	8W x 1	110-220V	585	66	46
PD29-1-L54161	吊掛型 Pendant Type	T5 LED 燈管 T5 LED Tube	16W x 1	110-220V	1185	66	46
PD29-1-141	吊掛型 Pendant Type	T5 日光燈管 T5Fluorescent Tube	14W x 1	110-220V	585	66	46
PD29-1-281	吊掛型 Pendant Type	T5 日光燈管 T5Fluorescent Tube	28W x 1	110-220V	1185	66	46



- ✧ 使用 LED T8 燈管。
- ✧ 使用高亮度 LED 4 尺燈管二支，燈光夠亮。
- ✧ 全鋁製造，精緻美觀。重量輕，安全效果佳。
- ✧ 內置鏡面鋁反光板，反光效果好。
- ✧ 使用擴散板遮罩。
- ✧ Use LED T8 tube.
- ✧ Use high-brightness two LED 4 foot tube, the light is bright enough.
- ✧ Aluminum made, exquisite beauty. Light weight and good safety.
- ✧ Built-in mirror aluminum reflector, good reflection effect.
- ✧ Use diffuser plate as the front cover.



型號 Model No.	光源 Light Source	功率 Wattage	輸入電壓 Input Voltage	燈光色溫 Color Temp.	主體尺寸 Size (mm)		
					長(L)	寬(W)	高(H)
PD29-2-L54162	T5 LED 燈管 T5 LED Tube	16W x 2	110V/220V	3000K/4000K/6000K	1185	170	47
PD29-2-282	T5 日光燈管 T5 Fluorescent Tube	28W x 2	110V/220V	3000K/4000K/6000K	1185	170	47
PD29-2-L84202	T8 LED 燈管 T8 LED Tube	20W x 2	110V/220V	3000K/4000K/6000K	1236	170	47

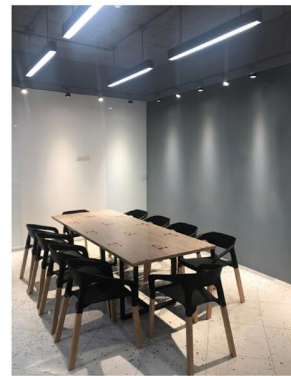

燈具顏色 Colors of lamp

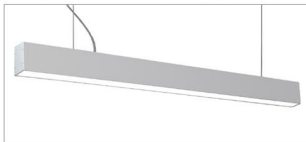

銀色 Silver

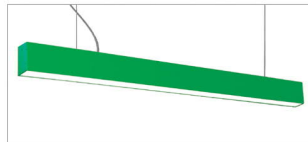

綠色 Green

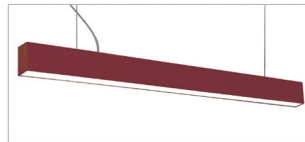

古典紅 Classical Red

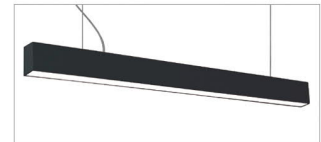

黑色 Black

- ◇ T5 / T8 燈管兩用型。
- ◇ 全鋁製造，精緻美觀。
- ◇ 內置鏡面鋁反光板，反光效果好。
- ◇ 防眩光鋁格柵或擴散板遮罩，可供選擇。
- ◇ 鋼絲或鐵管吊掛，可供選擇。
- ◇ 可選用飛利浦 T5 LED 燈管。

- ◇ T5 / T8 tube, dual purposes.
- ◇ Aluminum made, exquisite beauty.
- ◇ Built-in mirror aluminum reflector, good reflection effect.
- ◇ Antiglare aluminum grille or diffuser plate front cover for option.
- ◇ Steel wire or pendant pole for hanging is available for option.
- ◇ Philips T5 LED Tube is available for option.



本燈可加裝
WiFi / APP 遙控 智能調控裝置



台製配件
Accessories made in Taiwan

型號 Model No.	光源 Light Source	功率 Wattage	輸入電壓 Input Voltage	主體尺寸 Size (mm)		
				長(L)	寬(W)	高(H)
PD27-141	T5 日光燈管 T5 Fluorescent Tube	14W x 1	110V/220V	585	70	100
PD27-281	T5 日光燈管 T5 Fluorescent Tube	28W x 1	110V/220V	1185	70	100
PD27-L52081	T5 LED 燈管 T5 LED Tube	8W x 1	110V/220V	585	70	100
PD27-L52082	T5 LED 燈管 T5 LED Tube	8W x 2	110V/220V	585	70	100
PD27-L54161	T5 LED 燈管 T5 LED Tube	16W x 1	110V/220V	1185	70	100
PD27-L54162	T5 LED 燈管 T5 LED Tube	16W x 2	110V/220V	1185	70	100
PD27-L82101	T8 LED 燈管 T8 LED Tube	10W x 1	110V/220V	615	70	100
PD27-L84201	T8 LED 燈管 T8 LED Tube	20W x 1	110V/220V	1236	70	100

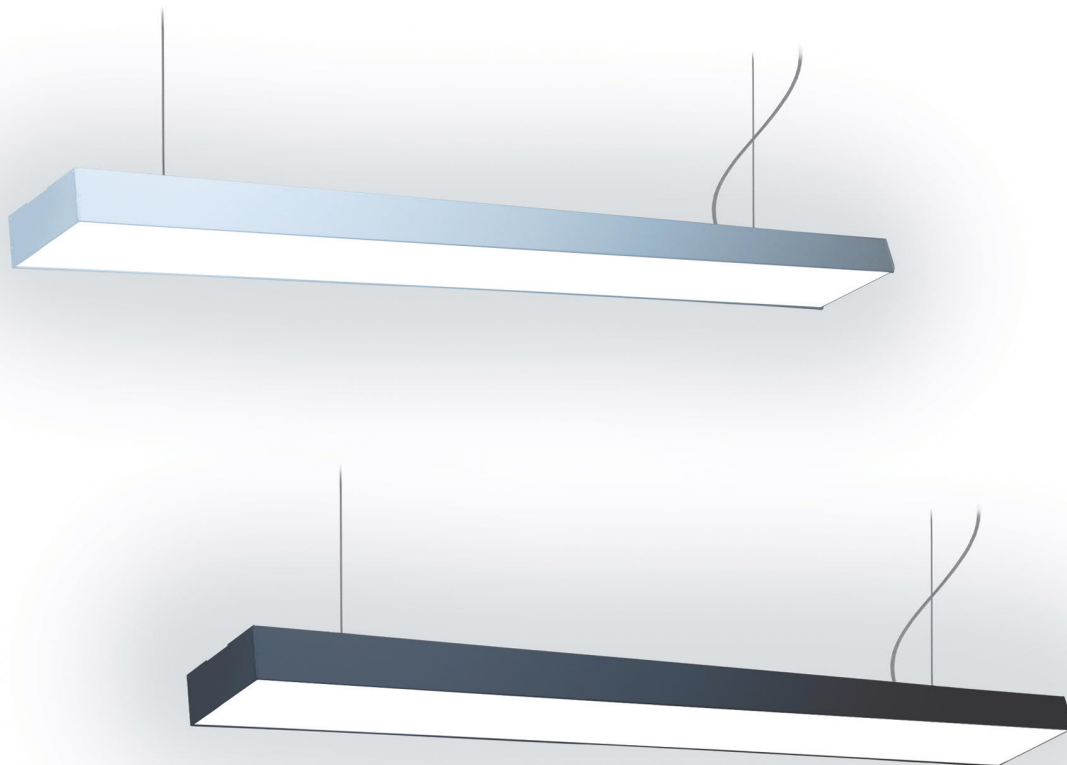

- ◇ 使用 LED T8 燈管。
- ◇ 使用高亮度 LED 4 尺燈管二支，燈光夠亮。
- ◇ 全鋁製造，精緻美觀。重量輕，安全效果佳。
- ◇ 內置鏡面鋁反光板，反光效果好。
- ◇ 使用擴散板遮罩。
- ◇ 鋼絲或鐵管吊掛，可供選擇。
- ◇ Use LED T8 tube.
- ◇ Use high-brightness two LED 4 foot tube, the light is bright enough.
- ◇ Aluminum made, exquisite beauty. Light weight and good safety.
- ◇ Built-in mirror aluminum reflector, good reflection effect.
- ◇ Use diffuser plate as the front cover.
- ◇ Steel wire or pendant pole for hanging is available for option.



WiFi / APP 遙控

本燈可加裝
智能調控裝置

台製配件

Accessories made in Taiwan

型號 Model No.	光源 Light Source	功率 Wattage	輸入電壓 Input Voltage	燈光色溫 Color Temp.	主體尺寸 Size (mm)		
					長(L)	寬(W)	高(H)
PD30-L52082	T5 LED 燈管 T5 LED Tube	8W x 2	110V/220V	3000K/4000K/6000K	580	125	65
PD30-142	T5 日光燈管 T5Fluorescent Tube	14W x 2	110V/220V	3000K/4000K/6000K	580	125	65
PD30-L54162	T5 LED 燈管 T5 LED Tube	16W x 2	110V/220V	3000K/4000K/6000K	1180	125	65
PD30-282	T5 日光燈管 T5Fluorescent Tube	28W x 2	110V/220V	3000K/4000K/6000K	1180	125	65
PD30-L82102	T8 LED 燈管 T8 LED Tube	10W x 2	110V/220V	3000K/4000K/6000K	615	125	65
PD30-L84202	T8 LED 燈管 T8 LED Tube	20W x 2	110V/220V	3000K/4000K/6000K	1236	125	65

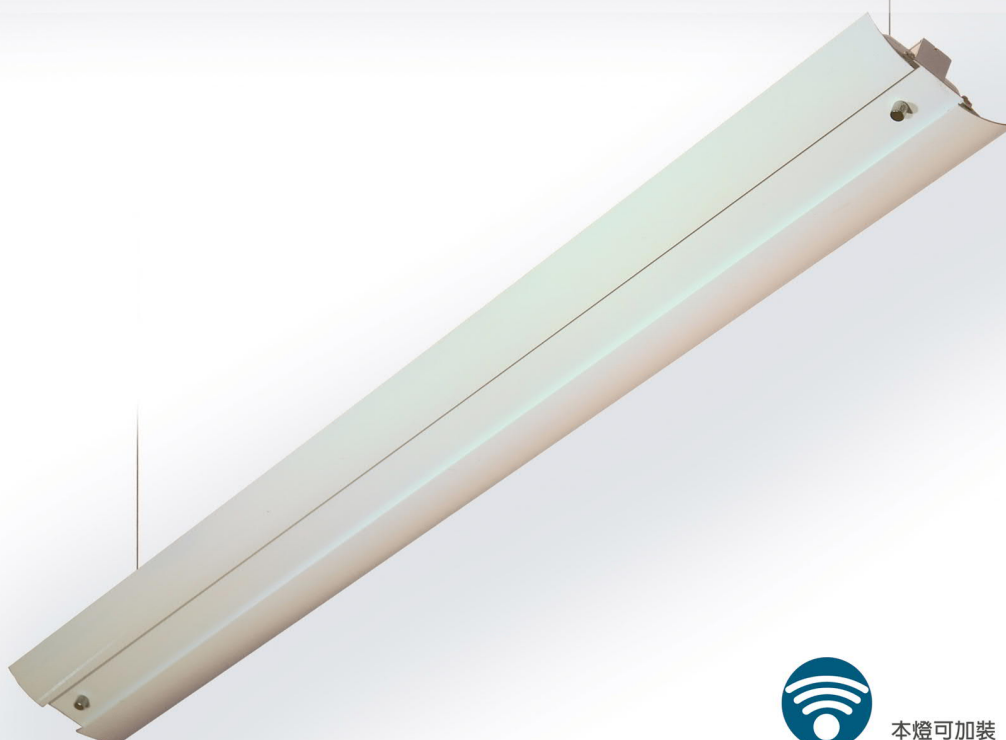

本燈可加裝
WiFi / APP 遙控
智能調控裝置



台製配件
Accessories made in Taiwan

- ◇ 上照型間接照明吊燈。
- ◇ 鋁擠型材質，輕巧精緻。
- ◇ 可選用飛利浦 T5 LED 燈管。

- ◇ An pendant lamp of up-light and indirect lighting.
- ◇ Aluminum extruded fixture with modern and stylish appearance.
- ◇ Philips T5 LED Tube is available for option.

型號 Model No.	光源 Light Source	功率 Wattage	輸入電壓 Input Voltage	主體尺寸 Size (mm)		
				長(L)	寬(W)	高(H)
PD26-142	T5 日光燈管 T5 Fluorescent Tube	14W x 2	110V/220V	660	173	60
PD26-212	T5 日光燈管 T5 Fluorescent Tube	21W x 2	110V/220V	960	173	60
PD26-282	T5 日光燈管 T5 Fluorescent Tube	28W x 2	110V/220V	1260	173	60
PD26-L52082	T5 LED 燈管 T5 LED Tube	8W x 2	110V/220V	660	173	60
PD26-L54162	T5 LED 燈管 T5 LED Tube	16W x 2	110V/220V	1260	173	60

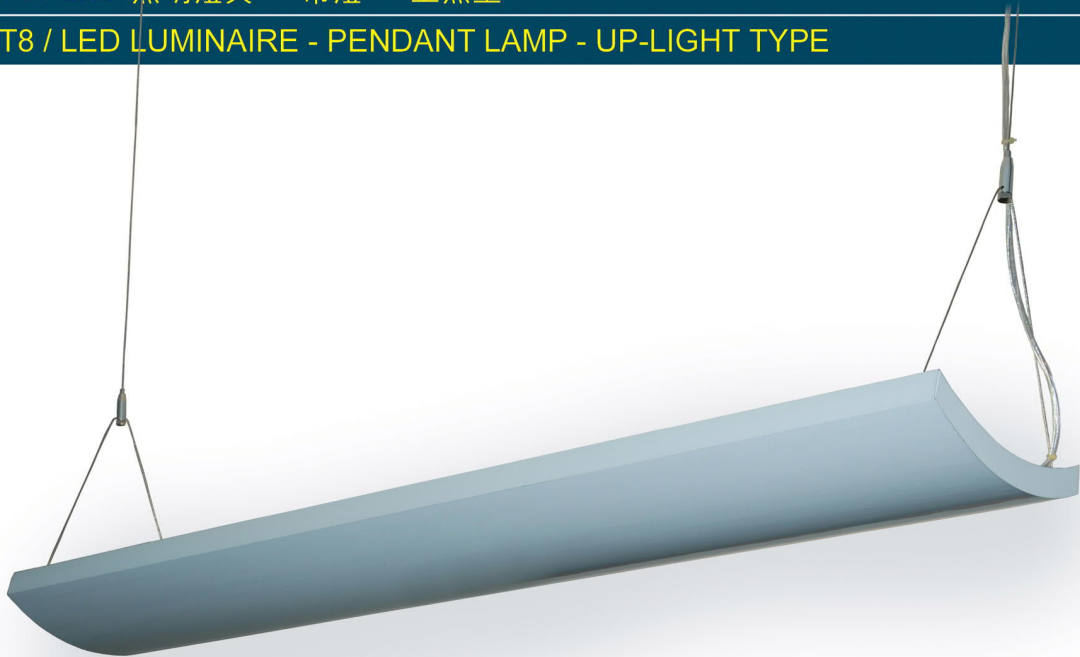

- ◇ 燈光上照型間接照明吊燈。
- ◇ 燈光柔和，眩光低。
- ◇ 燈具寬度 21 公分，造形美麗大方，適合大空間使用。
- ◇ 使用 LED T8 燈管。
- ◇ 使用高亮度 LED 4 尺燈管二支，燈光夠亮。

- ◇ An pendant lamp of up-light and indirect lighting.
- ◇ Soft lighting and low glare.
- ◇ The width of the luminaire is 21 cm, and the shape is beautiful and generous, suitable for large space use.
- ◇ Use LED T8 tube.
- ◇ Use high-brightness two LED 4 foot tube, the light is bright enough.



燈具頂部 燈光往上照再反射下來



本燈可加裝
WiFi / APP 遙控 智能調控裝置



台製配件
Accessories made in Taiwan

型號 Model No.	光源 Light Source	功率 Wattage	輸入電壓 Input Voltage	燈光色溫 Color Temp.	主體尺寸 Size (mm)		
					長(L)	寬(W)	高(H)
PD31-L54162	T5 LED 燈管 T5 LED Tube	16W x 2	110V/220V	3000K/4000K/6000K	1250	210	55
PD31-282	T5 日光燈管 T5Fluorescent Tube	28W x 2	110V/220V	3000K/4000K/6000K	1250	210	55
PD31-L84202	T8 LED 燈管 T8 LED Tube	20W x 2	110V/220V	3000K/4000K/6000K	1250	210	55

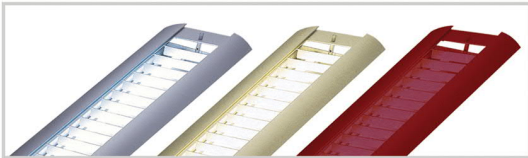
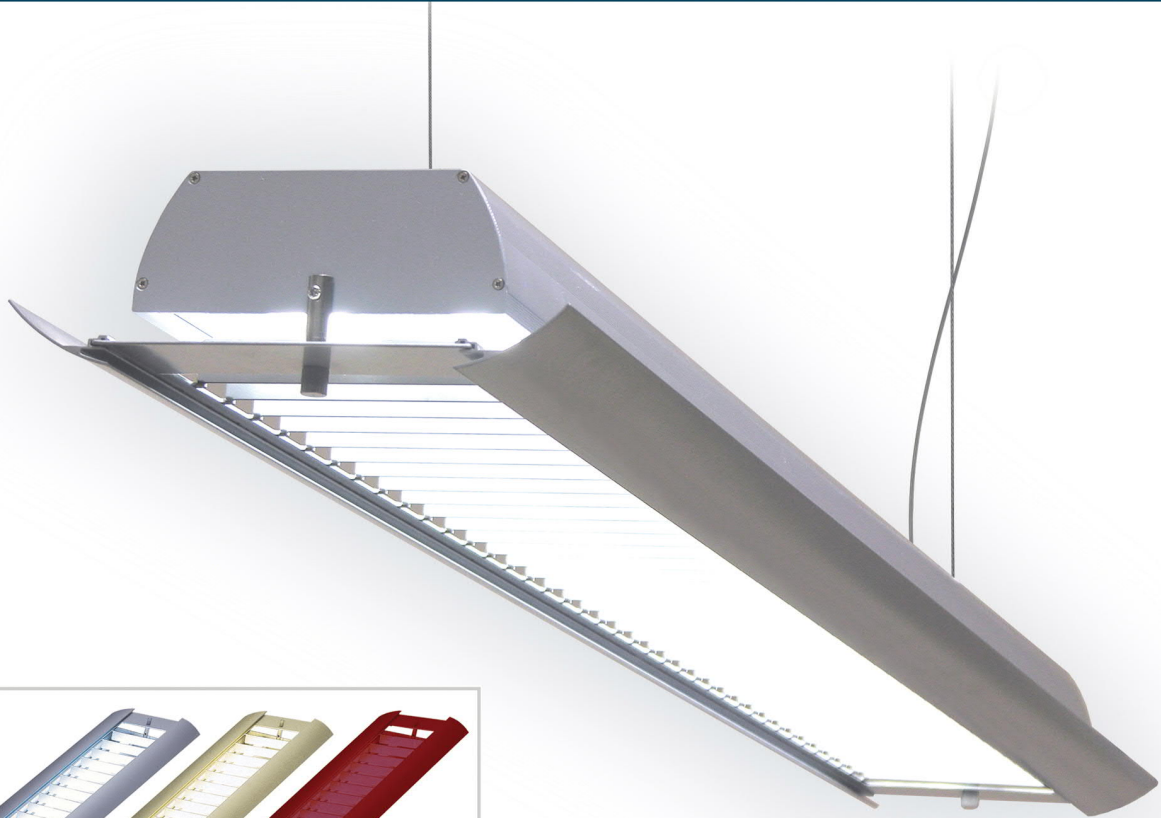

多種顏色可供選擇 Colors for option



本燈可加裝
WiFi / APP 遙控 智能調控裝置



台製配件
Accessories made in Taiwan

- ◇ 雙向照明，下照與上照兼具。
- ◇ 鋁擠型材質，輕巧精緻
- ◇ 防眩光格栅。
- ◇ T5 燈管/T8 燈管兩用。
- ◇ 可選用飛利浦 T5 LED 燈管。

- ◇ Dual lighting, down-light and up-light.
- ◇ Aluminum extruded fixture with modern and stylish appearance.
- ◇ Louvers for decreasing the glare.
- ◇ T5 tube / T8 tube, dual purposes.
- ◇ Philips T5 LED Tube is available for option.

型號 Model No.	光源 Light Source	功率 Wattage	輸入電壓 Input Voltage	主體尺寸 Size (mm)		
				長(L)	寬(W)	高(H)
PD14-212	T5 日光燈管 T5 Fluorescent Tube	21W x 2	110V/220V	960	220	85
PD14-282	T5 日光燈管 T5 Fluorescent Tube	28W x 2	110V/220V	1260	220	85
PD14-L54162	T5 LED 燈管 T5 LED Tube	16W x 2	110V/220V	1260	220	85
PD14-L84202	T8 LED 燈管 T8 LED Tube	20W x 2	110V/220V	1320	220	85

PD16 TYPE

PD16G TYPE



WiFi / APP 遙控

本燈可加裝
智能調控裝置



台製配件

Accessories made in Taiwan

- ◇ 鋁擠型燈具，鋁板厚實，鋁材質輕，結構堅固耐用。
- ◇ 防眩光格栅(PD16G)。
- ◇ 內置鏡面反射鋁板，反射效果佳。
- ◇ T5 燈管/T8 燈管兩用。
- ◇ 可選用飛利浦 T5 LED 燈管。
- ◇ An aluminum-extrude fixture with thick and light aluminum plate, and sturdy and durable structure.
- ◇ Louvers for decreasing the glare (PD16G).
- ◇ Aluminum mirror reflector installed for increasing the light.
- ◇ T5 tube / T8 tube, dual purposes.
- ◇ Philips T5 LED Tube is available for option.

型號 Model No.	光源 Light Source	功率 Wattage	輸入電壓 Input Voltage	主體尺寸 Size (mm)		
				長(L)	寬(W)	高(H)
PD16-142	T5 日光燈管 T5 Fluorescent Tube	14W x 2	110V/220V	578	145	55
PD16-212	T5 日光燈管 T5 Fluorescent Tube	21W x 2	110V/220V	878	145	55
PD16-282	T5 日光燈管 T5 Fluorescent Tube	28W x 2	110V/220V	1178	145	55
PD16-L52082	T5 LED 燈管 T5 LED Tube	8W x 2	110V/220V	578	145	55
PD16-L54162	T5 LED 燈管 T5 LED Tube	16W x 2	110V/220V	1178	145	55
PD16-L82102	T8 LED 燈管 T8 LED Tube	10W x 2	110V/220V	608	145	55
PD16-L84202	T8 LED 燈管 T8 LED Tube	20W x 2	110V/220V	1245	145	55
PD16G-142	T5 日光燈管 T5 Fluorescent Tube	14W x 2	110V/220V	578	145	68
PD16G-212	T5 日光燈管 T5 Fluorescent Tube	21W x 2	110V/220V	878	145	68
PD16G-282	T5 日光燈管 T5 Fluorescent Tube	28W x 2	110V/220V	1178	145	68
PD16G-L52082	T5 LED 燈管 T5 LED Tube	8W x 2	110V/220V	578	145	68
PD16G-L54162	T5 LED 燈管 T5 LED Tube	16W x 2	110V/220V	1178	145	68
PD16G-L82102	T8 LED 燈管 T8 LED Tube	10W x 2	110V/220V	608	145	68
PD16G-L84202	T8 LED 燈管 T8 LED Tube	20W x 2	110V/220V	1245	145	68

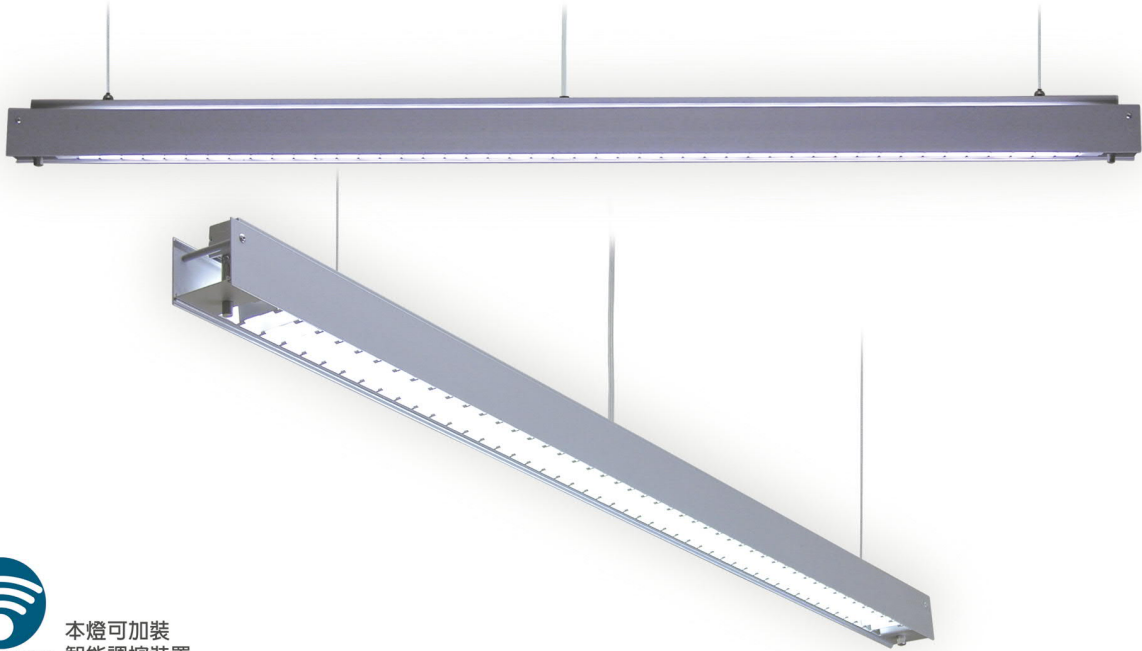

本燈可加裝
智能調控裝置

WiFi / APP 遙控



- ◇ 雙向照明，下照與上照兼具。
- ◇ 鋁擠型材質，輕巧精緻
- ◇ 防眩光格柵。
- ◇ 可選用飛利浦 T5 LED 燈管。

- ◇ Dual lighting, down-light and up-light.
- ◇ Aluminum extruded fixture with modern and stylish appearance.
- ◇ Louvers for decreasing the glare.
- ◇ Philips T5 LED Tube is available for option.



台製配件
Accessories made in Taiwan

型號 Model No.	光源 Light Source	功率 Wattage	輸入電壓 Input Voltage	主體尺寸 Size (mm)		
				長(L)	寬(W)	高(H)
PD19-141	T5 日光燈管 T5 Fluorescent Tube	14W x 1	110V/220V	640	55	65
PD19-211	T5 日光燈管 T5 Fluorescent Tube	21W x 1	110V/220V	940	55	65
PD19-281	T5 日光燈管 T5 Fluorescent Tube	28W x 1	110V/220V	1240	55	65
PD19-L52081	T5 LED 燈管 T5 LED Tube	8W x 1	110V/220V	640	55	65
PD19-L54161	T5 LED 燈管 T5 LED Tube	16W x 1	110V/220V	1240	55	65
PD19-L82101	T8 LED 燈管 T8 LED Tube	10W x 1	110V/220V	680	55	65
PD19-L84201	T8 LED 燈管 T8 LED Tube	20W x 1	110V/220V	1300	55	65

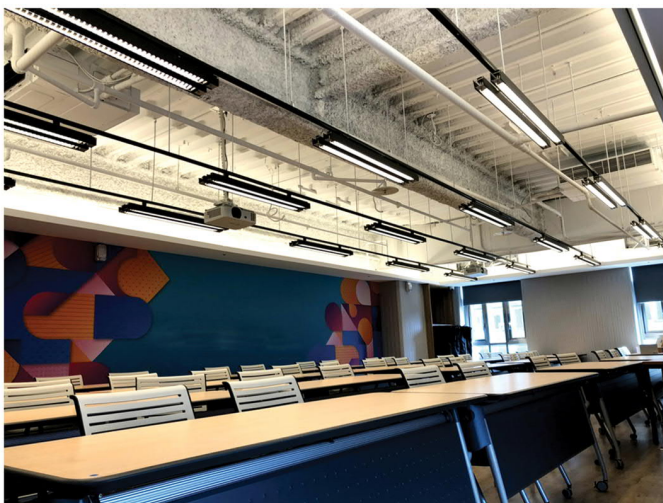
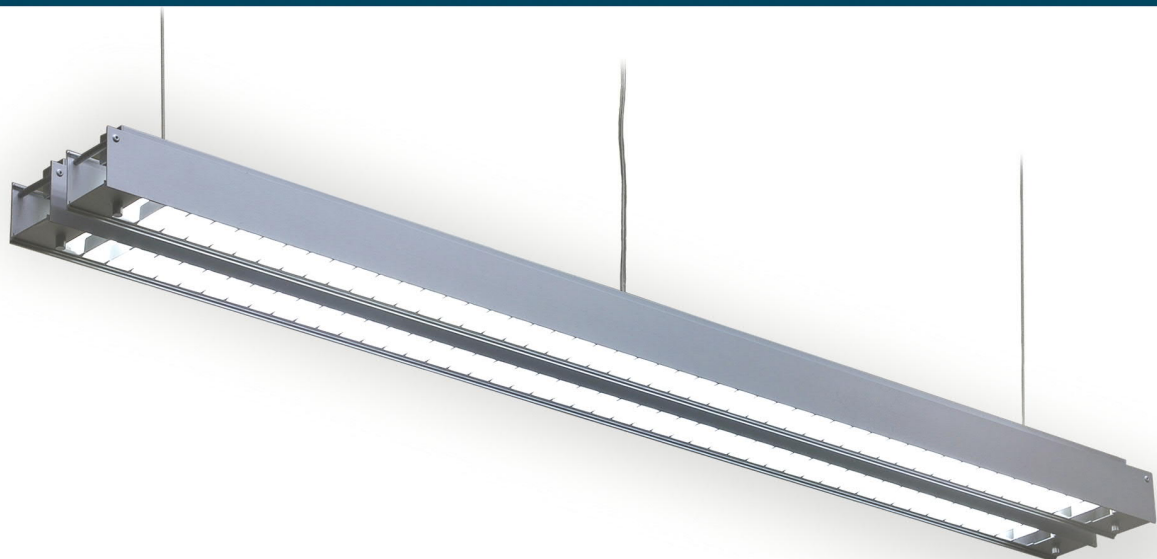

- ◇ 雙向照明，下照與上照兼具。
- ◇ 鋁擠型材質，輕巧精緻
- ◇ 防眩光格柵。
- ◇ 可選用飛利浦 T5 LED 燈管。
- ◇ Dual lighting, down-light and up-light.
- ◇ Aluminum extruded fixture with modern and stylish appearance.
- ◇ Louvers for decreasing the glare.
- ◇ Philips T5 LED Tube is available for option.



本燈可加裝
WiFi / APP 遙控 智能調控裝置



台製配件
Accessories made in Taiwan

型號 Model No.	光源 Light Source	功率 Wattage	輸入電壓 Input Voltage	主體尺寸 Size (mm)		
				長(L)	寬(W)	高(H)
PD20-142	T5 日光燈管 T5 Fluorescent Tube	14W x 2	110V/220V	640	132	65
PD20-212	T5 日光燈管 T5 Fluorescent Tube	21W x 2	110V/220V	940	132	65
PD20-282	T5 日光燈管 T5 Fluorescent Tube	28W x 2	110V/220V	1240	132	65
PD20-L52082	T5 LED 燈管 T5 LED Tube	8W x 2	110V/220V	640	132	65
PD20-L54162	T5 LED 燈管 T5 LED Tube	16W x 2	110V/220V	1240	132	65
PD20-L82102	T8 LED 燈管 T8 LED Tube	10W x 2	110V/220V	680	132	65
PD20-L84202	T8 LED 燈管 T8 LED Tube	20W x 2	110V/220V	1300	132	65



- ◇ 防眩光格柵。(可選用壓克力燈罩。)
- ◇ 鋁擠型材質，輕巧精緻。
- ◇ 鋼絲或鐵管吊掛，可供選擇。
- ◇ 可選用飛利浦 T5 LED 燈管。

- ◇ Louvers for decreasing the glare. (Acrylic cover is available for option.)
- ◇ Aluminum extruded fixture with modern and stylish appearance.
- ◇ Steel wire or pendant pole for hanging is available for option.
- ◇ Philips T5 LED Tube is available for option.



本燈可加裝
WiFi / APP 遙控
智能調控裝置



台製配件
Accessories made in Taiwan

型號 Model No.	光源 Light Source	功率 Wattage	輸入電壓 Input Voltage	主體尺寸 Size (mm)		
				長(L)	寬(W)	高(H)
PD22-141	T5 日光燈管 T5 Fluorescent Tube	14W x 1	110V/220V	578	60	85
PD22-211	T5 日光燈管 T5 Fluorescent Tube	21W x 1	110V/220V	878	60	85
PD22-281	T5 日光燈管 T5 Fluorescent Tube	28W x 1	110V/220V	1178	60	85
PD22-L52081	T5 LED 燈管 T5 LED Tube	8W x 1	110V/220V	578	60	85
PD22-L54161	T5 LED 燈管 T5 LED Tube	16W x 1	110V/220V	1178	60	85
PD22-L82101	T8 LED 燈管 T8 LED Tube	10W x 1	110V/220V	615	60	85
PD22-L84201	T8 LED 燈管 T8 LED Tube	20W x 1	110V/220V	1236	60	85



- ✧ 側邊造形酷似展翅翔鷹，簡稱『鷹式燈』。
- ✧ 雙向照明，下照與上照兼具。
- ✧ 鋁擠型材質，輕巧精緻
- ✧ T5 燈管/T8 燈管兩用。
- ✧ 可選用飛利浦 T5 LED 燈管。

- ✧ The side-shape resembles a flying hawk, nicknamed “Hawk Lamp”.
- ✧ Dual lighting, down-light and up-light.
- ✧ Aluminum extruded fixture with modern and stylish appearance.
- ✧ T5 tube / T8 tube, dual purposes.
- ✧ Philips T5 LED Tube is available for option.



WiFi / APP 遙控

本燈可加裝
智能調控裝置



台製配件

Accessories made in Taiwan

型號 Model No.	光源 Light Source	功率 Wattage	輸入電壓 Input Voltage	主體尺寸 Size (mm)		
				長(L)	寬(W)	高(H)
PD18-141	T5 日光燈管 T5 Fluorescent Tube	14W x 1	110V/220V	654	126	48
PD18-211	T5 日光燈管 T5 Fluorescent Tube	21W x 1	110V/220V	954	126	48
PD18-281	T5 日光燈管 T5 Fluorescent Tube	28W x 1	110V/220V	1254	126	48
PD18-L52081	T5 LED 燈管 T5 LED Tube	8W x 1	110V/220V	654	126	48
PD18-L54161	T5 LED 燈管 T5 LED Tube	16W x 1	110V/220V	1254	126	48
PD18-L82101	T8 LED 燈管 T8 LED Tube	10W x 1	110V/220V	684	126	48
PD18-L84201	T8 LED 燈管 T8 LED Tube	20W x 1	110V/220V	1305	126	48

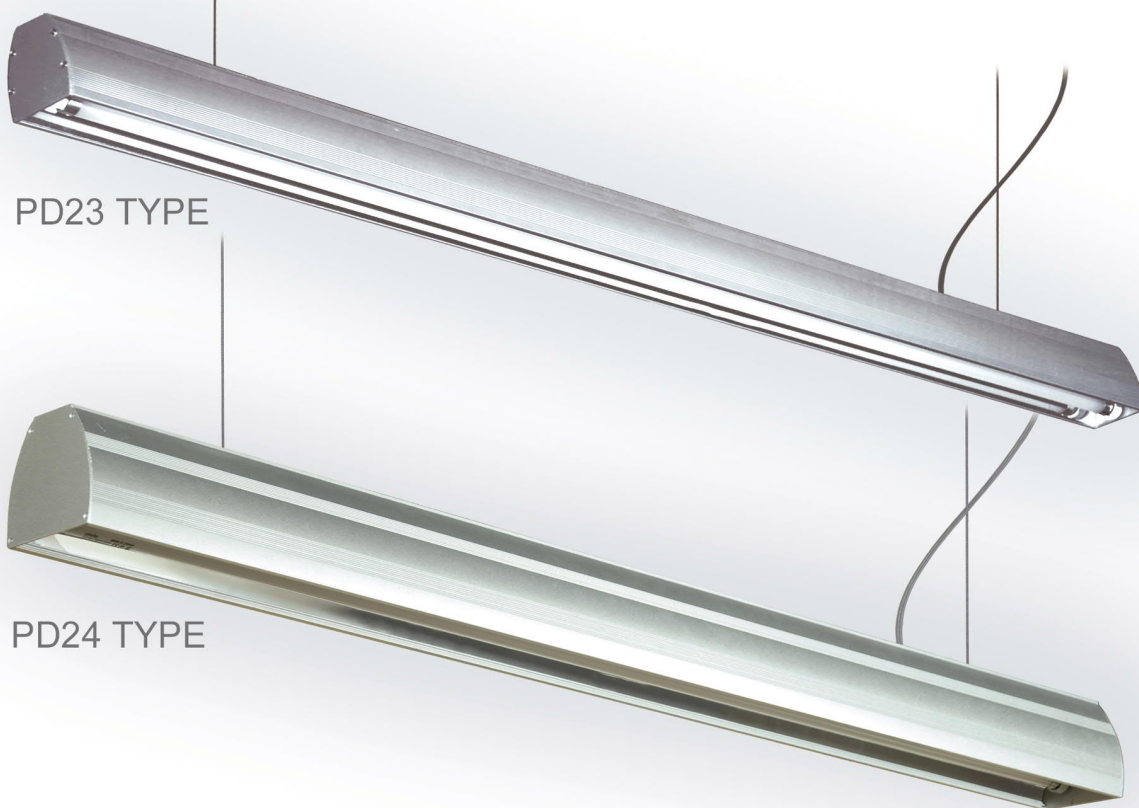

顏色可選擇:

Colors for selection:



Silver



White



Black



Gold



Green



WiFi / APP 遙控

本燈可加裝
智能調控裝置



台製配件

Accessories made in Taiwan

- ◇ 鋁擠型燈具，鋁板厚實，鋁材質輕，結構堅固耐用。
- ◇ 造型具現代感，高雅精巧美觀。
- ◇ 內置鏡面反射鋁板，反射效果佳。
- ◇ 可選用飛利浦 T5 LED 燈管。
- ◇ An aluminum-extrude fixture with thick and light aluminum plate, and sturdy and durable structure.
- ◇ Modern appearance, elegant, exquisite and stylish.
- ◇ Aluminum mirror reflector installed for increasing the light.
- ◇ Philips T5 LED Tube is available for option.

型號 Model No.	光源 Light Source	功率 Wattage	輸入電壓 Input Voltage	主體尺寸 Size (mm)		
				長(L)	寬(W)	高(H)
PD23-141	T5 日光燈管 T5 Fluorescent Tube	14W x 1	110V/220V	578	50	58
PD23-211	T5 日光燈管 T5 Fluorescent Tube	21W x 1	110V/220V	878	50	58
PD23-281	T5 日光燈管 T5 Fluorescent Tube	28W x 1	110V/220V	1178	50	58
PD23-L52081	T5 LED 燈管 T5 LED Tube	8W x 1	110V/220V	578	50	58
PD23-L54161	T5 LED 燈管 T5 LED Tube	16W x 1	110V/220V	1178	50	58
PD24-142	T5 日光燈管 T5 Fluorescent Tube	14W x 2	110V/220V	578	93	63
PD24-212	T5 日光燈管 T5 Fluorescent Tube	21W x 2	110V/220V	878	93	63
PD24-282	T5 日光燈管 T5 Fluorescent Tube	28W x 2	110V/220V	1178	93	63
PD24-L52082	T5 LED 燈管 T5 LED Tube	8W x 2	110V/220V	578	93	63
PD24-L54162	T5 LED 燈管 T5 LED Tube	16W x 2	110V/220V	1178	93	63
PD24-L82101	T8 LED 燈管 T8 LED Tube	10W x 1	110V/220V	615	93	63
PD24-L84201	T8 LED 燈管 T8 LED Tube	20W x 1	110V/220V	1236	93	63

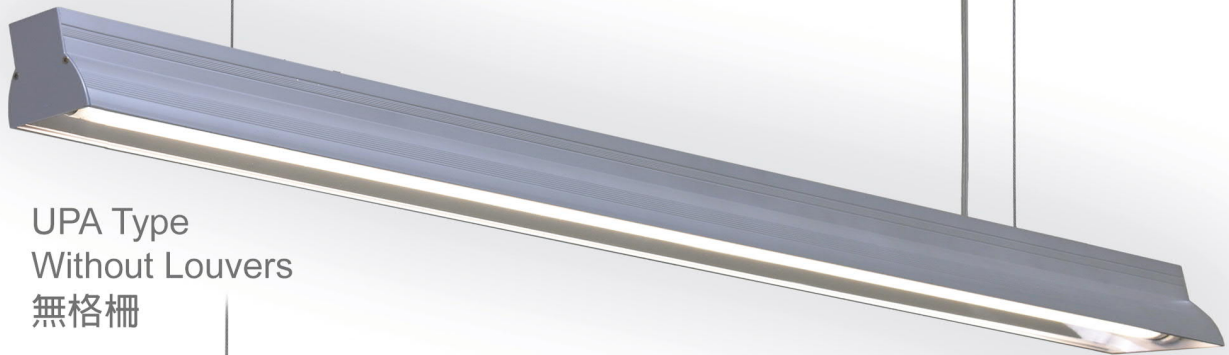

UPA Type
Without Louvers
無格柵

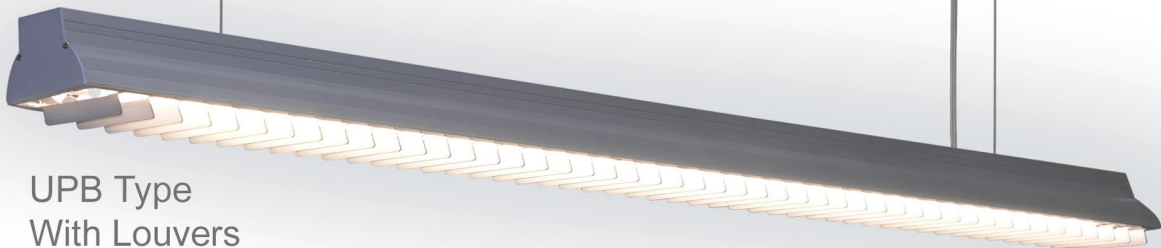

UPB Type
With Louvers
有格柵

- ◇ 鋁擠型燈具，鋁板厚實，鋁材質輕，結構堅固耐用。
- ◇ 防眩光格柵(UPB Type)。
- ◇ 內置鏡面反射鋁板，反射效果佳。
- ◇ 台灣製造，品質優良。
- ◇ An aluminum-extrude fixture with thick and light aluminum plate, and sturdy and durable structure.
- ◇ Louvers for decreasing the glare (UPB Type).
- ◇ Aluminum mirror reflector installed for increasing the light.
- ◇ Made in Taiwan with high quality.



本燈可加裝
WiFi / APP 遙控
智能調控裝置



台製配件
Accessories made in Taiwan

型號 Model No.	光源 Light Source	功率 Wattage	輸入電壓 Input Voltage	主體尺寸 Size (mm)		
				長(L)	寬(W)	高(H)
UPA-14	T5 日光燈管 T5 Fluorescent Tube	14W x 1	110V / 220v	578	50	58
UPA-28	T5 日光燈管 T5 Fluorescent Tube	28W x 1	110V / 220v	1178	50	58
UPA-L52081	T5 LED 燈管 T5 LED Tube	8W x 1	110V / 220v	578	50	58
UPA-L54161	T5 LED 燈管 T5 LED Tube	16W x 1	110V / 220v	1178	50	58
UPB-14	T5 日光燈管 T5 Fluorescent Tube	14W x 1	110V / 220v	578	50	73
UPB-28	T5 日光燈管 T5 Fluorescent Tube	28W x 1	110V / 220v	1178	50	73
UPB-L52081	T5 LED 燈管 T5 LED Tube	8W x 1	110V / 220v	578	50	73
UPB-L54161	T5 LED 燈管 T5 LED Tube	16W x 1	110V / 220v	1178	50	73

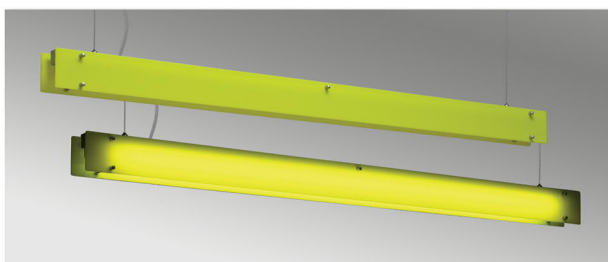
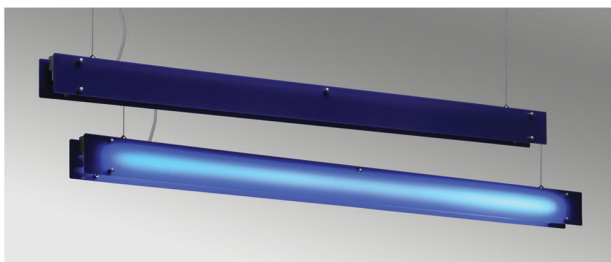
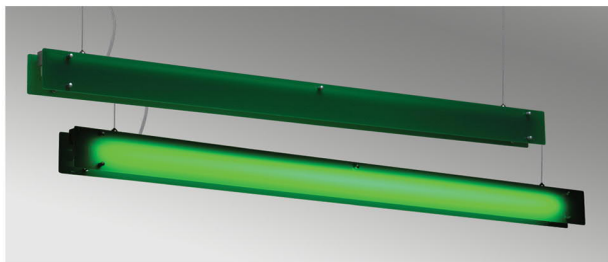

- ◇ 雙向照明，下照與上照兼具。
- ◇ 鋁擠型主體+彩色壓克力遮板。
- ◇ 備有各種顏色遮板，接受客製化訂做。
- ◇ 可選用飛利浦 T5 LED 燈管。

- ◇ Dual lighting, down-light and up-light.
- ◇ Aluminum extruded fixture plus colored acrylic shade.
- ◇ Varied colored shades are available for option, customization is acceptable.
- ◇ Philips T5 LED Tube is available for option.



台製配件
Accessories made in Taiwan

型號 Model No.	光源 Light Source	功率 Wattage	輸入電壓 Input Voltage	主體尺寸 Size (mm)		
				長(L)	寬(W)	高(H)
PD21-141	T5 日光燈管 T5 Fluorescent Tube	14W x 1	110V/220V	620	78	72
PD21-211	T5 日光燈管 T5 Fluorescent Tube	21W x 1	110V/220V	920	78	72
PD21-281	T5 日光燈管 T5 Fluorescent Tube	28W x 1	110V/220V	1220	78	72
PD21-L52081	T5 LED 燈管 T5 LED Tube	8W x 1	110V/220V	620	78	72
PD21-L54161	T5 LED 燈管 T5 LED Tube	16W x 1	110V/220V	1220	78	72
PD21-L82101	T8 LED 燈管 T8 LED Tube	10W x 1	110V/220V	700	83	100
PD21-L84201	T8 LED 燈管 T8 LED Tube	20W x 1	110V/220V	1320	83	100



- ◇ 磨光鋼板白色烤漆，造型新穎美觀。
- ◇ 側邊造型酷似烏魚子，簡稱『烏魚子燈』。
- ◇ T5 燈管/T8 燈管兩用。
- ◇ 可選用飛利浦 T5 LED 燈管。

- ◇ Steel (SPCC) white coating with modern and stylish appearance.
- ◇ T5 tube / T8 tube, dual purposes.
- ◇ Philips T5 LED Tube is available for option.

型號 Model No.	光源 Light Source	功率 Wattage	輸入電壓 Input Voltage	主體尺寸 Size (mm)		
				長(L)	寬(W)	高(H)
PD17-282	T5 日光燈管 T5 Fluorescent Tube	28W x 2	110V/220V	1240	240	60
PD17-L54162	T5 LED 燈管 T5 LED Tube	16W x 2	110V/220V	1240	240	60
PD17-L84202	T8 LED 燈管 T8 LED Tube	20W x 2	110V/220V	1240	240	60

*上述之高度不含吊桿之高度。The height does not include the pendant pole.

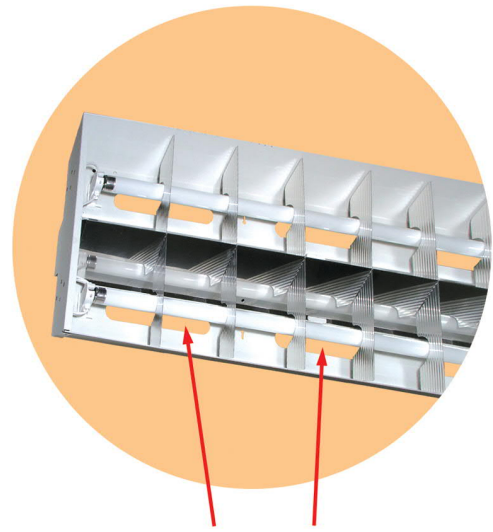
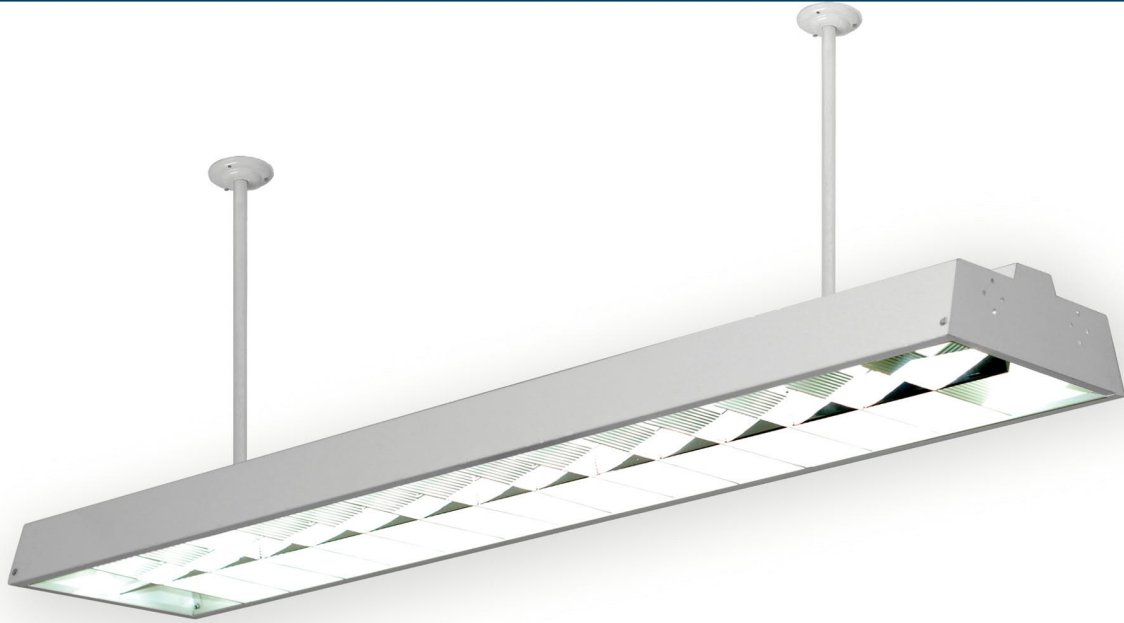

上照透光孔
Light hole for up-light

- ◇ 磨光鋼板白色烤漆。
- ◇ 雙向照明，下照與上照兼具。
- ◇ 防眩光格栅。
- ◇ T5 燈管/T8 燈管兩用。
- ◇ 可選用飛利浦 T5 LED 燈管。
- ◇ Steel (SPCC) coating fixture.
- ◇ Dual lighting, down-light and up-light.
- ◇ Louvers for decreasing the glare.
- ◇ T5 tube / T8 tube, dual purposes.
- ◇ Philips T5 LED Tube is available for option.

型號 Model No.	光源 Light Source	功率 Wattage	輸入電壓 Input Voltage	主體尺寸 Size (mm)		
				長(L)	寬(W)	高(H)
C12-282	T5 日光燈管 T5 Fluorescent Tube	28W x 2	110V/220V	1167	240	65
C12-L54162	T5 LED 燈管 T5 LED Tube	16W x 2	110V/220V	1167	240	65
C12-L84202	T8 LED 燈管 T8 LED Tube	20W x 2	110V/220V	1218	240	65



- ◇ 磨光鋼板白色烤漆。
- ◇ 內置鏡面反射鋁板，反射效果佳。
- ◇ T5 燈管 / LED T8 燈管兩用。

- ◇ Steel (SPCC) coating fixture
- ◇ Aluminum mirror reflector installed for increasing the light.
- ◇ T5 tube / LED T8 tube, dual purposes.

型號 Model No.	光源 Light Source	功率 Wattage	輸入電壓 Input Voltage	主體尺寸 Size (mm)		
				長(L)	寬(W)	高(H)
B2-281	T5 日光燈管 T5 Fluorescent Tube	28W x 1	110V/220V	1174	170	140
B2-282	T5 日光燈管 T5 Fluorescent Tube	28W x 2	110V/220V	1174	170	140
B2-L54161	T5 LED 燈管 T5 LED Tube	16W x 1	110V/220V	1174	170	140
B2-L54162	T5 LED 燈管 T5 LED Tube	16W x 2	110V/220V	1174	170	140
B2-L84201	T8 LED 燈管 T8 LED Tube	20W x 1	110V/220V	1225	170	140
B2-L84202	T8 LED 燈管 T8 LED Tube	20W x 2	110V/220V	1225	170	140



WiFi / APP 遙控

本燈可加裝
智能調控裝置

SP-LPD16G



SP-LPD27

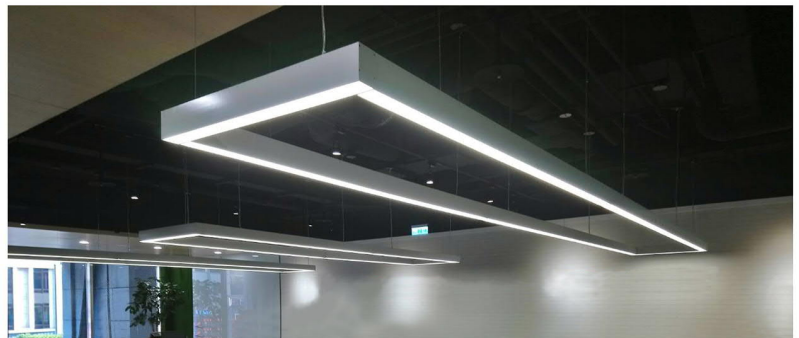
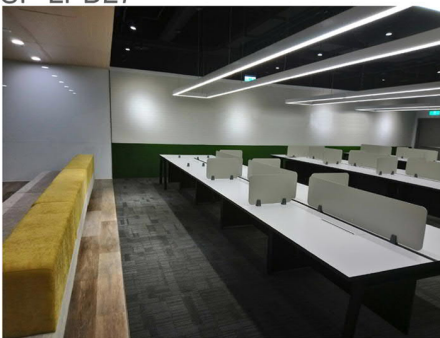

- ◇ 型號：SP-LPD16G / SP-LPD27
- ◇ 光源：LED
- ◇ 材質：鋁擠型。
- ◇ 尺寸：可依選用之不同燈具與使用現場之需要串接延長。
- ◇ 安裝方式：吊掛、吸附屋頂。
- ◇ 特色：
 - 鋁材重量輕，吊掛安全。
 - 鋁擠造型現代美麗。
 - 串接整齊平順。
 - 長度可依使用現場之需要而變化。

- ◇ Model No. : SP-LPD16G / SPLPD27
- ◇ Light Source : LED.
- ◇ Material of Housing : Extruded Aluminum.
- ◇ Size : can be extended in series according to the needs of different lamps and use sites.
- ◇ Installation : Suspended or mounted from the ceiling.
- ◇ Features :
 - Using aluminum, lighter in weight makes safety of suspending.
 - With the stylish and elegant appearance.
 - Connection between lamps is straight and smooth.
 - Length can vary depending on the needs of the site

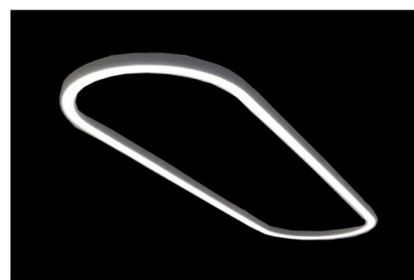
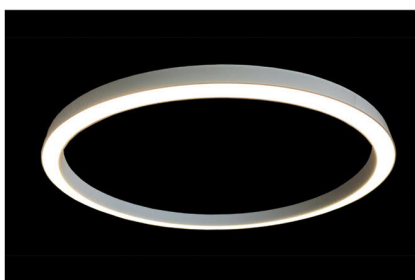

LED 大圓環形燈具

客製化燈具

形狀、大小、色溫、功能、…… 皆依客戶之需求而製作

光源：LED

製造地點：台灣製造

歡迎洽詢



WiFi / APP 遙控

本燈可加裝
智能調控裝置



細長型 LED 中東燈

可串接 **無暗區** **不斷光**
Connectible No Darkness Areas Constant Light

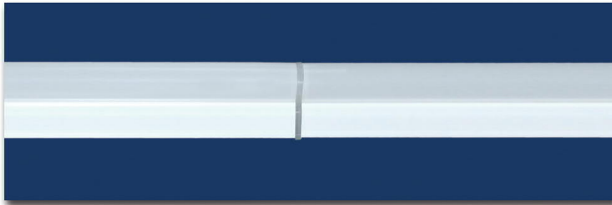

- 可串接：一體成型，取代 T5 日光燈，體積更小，可供作間接照明之用燈。
- 無暗區：無燈頭與燈座，燈管不會出現黑暗區。
- 不斷光：無燈頭與燈座，串接時不會斷光。
- 尺寸細長，適合安裝於狹長之空間。
- 鋁擠型材質，輕巧精緻。
- 節省用電：耗電僅 T5 日光燈的一半。耗電低，節省電費。作為間接照明之用途，採用適量之燈光，不浪費用電，以節省電費。
- Connectible: One piece forming, replace T5 fluorescent lamp, smaller in size, available for indirect lighting purposes.
- No darkness areas: Without cap and socket, no darkness areas on the tube.
- Constant light: Without cap and socket, light between tubes will not be broken when connected.
- Slim size, suitable for installation in the narrow space.
- Saving electricity: Power consumption is only half of T5 fluorescent lamps. Low power consumption, save money.



型號 Model No.	光源 Light Source	電壓 Voltage	功率 Watt	色溫 Color Temp.	主體尺寸 Size (mm)		
					長(L)	寬(W)	高(H)
QL-2-1	LED	110-220V	5W	6000K / 4000K / 3000K	310	23	32
QL-2-2	LED	110-220V	10W	6000K / 4000K / 3000K	570	23	32
QL-2-3	LED	110-220V	15W	6000K / 4000K / 3000K	870	23	32
QL-2-4	LED	110-220V	20W	6000K / 4000K / 3000K	1170	23	32



可以變換燈光顏色的LED燈 Changeable Light Color LED Lamp

6000K ↔ 4000K ↔ 3000K

使用電源開關可切換燈光色溫
三種顏色變換 不須更換光源/燈具

情境照明 1支抵3支 1台抵3台

T5 LED三色不斷光串接燈 T5 LED TRICOLOR CONNECTIBLE LAMP



型號 Model No.	光源 Light Source	電壓 Voltage	功率 Watt	主體尺寸 Size (mm)		
				長(L)	寬(W)	高(H)
CC-1-2	LED	110-220V	7W	570	23	32
CC-1-4	LED	110-220V	14W	1170	23	32

LED三色嵌燈

LED TRICOLOR RECESSED LAMP



型號 Model No.	光源 Light Source	電壓 Voltage	功率 Watt	嵌入孔徑 Hole Dia.	燈具高度 Height
CC-2-12W	LED	110-220V	12W	15 cm	2.6 cm



1
嵌入孔(⌀): 9.5 cm



2
嵌入孔(⌀): 12 cm



3
嵌入孔(⌀): 15 cm



4
嵌入孔(⌀): 20 cm

序 號 SEQ. NO.	型 號 MODEL NO.	燈具尺寸 LAMP SIZE			LED 型式 LED TYPE	消耗功率 POWER DISSIPATION	輸入電壓 INPUT VOLTAGE	光源色溫 COLOR TEMP.
		嵌入孔徑 HOLE Ø	燈具外徑 OUTER Ø	燈具高度 HEIGHT				
1	MK2-RE-9507	9.5 CM	11.5 CM	3.0 CM	SMD	7W	85-265V	3000K / 6000K
2	MK2-RE-1210	12.0 CM	13.8 CM	3.5 CM	SMD	10W	85-265V	3000K / 6000K
3	MK2-RE-1512	15.0 CM	17.7 CM	3.8 CM	SMD	12W	85-265V	3000K / 6000K
4	MK2-RE-2024	20.0 CM	22.3 CM	3.8 CM	SMD	24W	85-265V	3000K / 6000K

防水 + 防鹽霧

使用高效率冷熱交換奈米薄膜塗佈



嵌入孔(⌀) : 9.5 cm



嵌入孔(⌀) : 15 cm



嵌入孔(⌀) : 20 cm

奈米薄膜直接塗佈於 LED 燈珠與電子零件上，達到防護效果，不須在燈殼上做防護。

- ◆ 通過 CNS 驗證
- ◆ 通過 CNS8886 RN10 鹽霧測試
- ◆ 通過 IP68 防塵防水測試

適用場所：

空氣潮濕或鹽分高地方，海邊環境、溫泉區、游泳池、三溫暖、家庭浴室、廁所、廚房、陽台等。

型號 MODEL NO.	燈具尺寸 LAMP SIZE			消耗功率 WATT	輸入電壓 VOLT	功率因素 PF	演色性 CRI	防護等級 IPR	光源色溫 COLOR TEMP.
	嵌入孔徑 HOLE Ø	燈具外徑 OUTER Ø	燈具高度 HEIGHT						
WTF-A0910-830	9.5 CM	12 CM	3.0 CM	10W	100-240V	>95%	>80%	IP68	3000K
WTF-A0910-840	9.5 CM	12 CM	3.0 CM	10W	100-240V	>95%	>80%	IP68	4000K
WTF-A0910-857	9.5 CM	12 CM	3.0 CM	10W	100-240V	>95%	>80%	IP68	5700K
WTF-A1516-830	15.0 CM	18 CM	4.0 CM	16W	100-240V	>95%	>80%	IP68	3000K
WTF-A1516-840	15.0 CM	18 CM	4.0 CM	16W	100-240V	>95%	>80%	IP68	4000K
WTF-A1516-857	15.0 CM	18 CM	4.0 CM	16W	100-240V	>95%	>80%	IP68	5700K
WTF-A2030-830	20.0 CM	22 CM	5.0 CM	30W	100-240V	>95%	>80%	IP68	3000K
WTF-A2030-840	20.0 CM	22 CM	5.0 CM	30W	100-240V	>95%	>80%	IP68	4000K
WTF-A2030-857	20.0 CM	22 CM	5.0 CM	30W	100-240V	>95%	>80%	IP68	5700K

SPOT LAMP



序號 SEQ. NO.	型號 MODEL NO.	燈珠顆數 LED Q'TY	嵌入孔徑 HOLE Ø	燈具外徑 OUTER Ø	功率 WATTAGE	輸入電壓 VOLTAGE	光源色溫 COLOR TEMP.
1	SPL-0951-10W	7	95mm	109mm	10W	110V-220V	3000K / 4000K / 5700K
2	SPL-0951-12W	9	95mm	109mm	12W	110V-220V	3000K / 4000K / 5700K
3	SPL-0951-15W	12	95mm	109mm	15W	110V-220V	3000K / 4000K / 5700K

MR16 LAMP



序號 SEQ. NO.	型號 MODEL NO.	燈珠顆數 LED Q'TY	功率 WATT	輸入電壓 VOLT	光束角度 BEAM ANGLE	光源色溫 COLOR TEMP.	燈泡尺寸(mm) LAMP SIZE
1	MR16-3-5W12V	3	5W	DC12V*	30°	3000K / 6000K	ø51mm x H52 mm
2	MR16-4-5W-U	4	5W	AC85-265V	30°	2700K / 3000K / 4000K / 6000K	ø51mm x H52 mm
3	MR16-7-7W-U	7	7W	AC85-265V	38°	3000K / 4000K / 6000K	ø51mm x H50 mm

*DC12V 附電源 With Power

AR70 LAMP



序號 SEQ. NO.	型號 MODEL NO.	燈珠顆數 LED Q'TY	功率 WATT	輸入電壓 VOLT	光束角度 BEAM ANGLE	光源色溫 COLOR TEMP.	燈泡尺寸(mm) LAMP SIZE
1	AR70-C-7-7W	7	7W	AC85-265V	120°	3000K / 4000K / 6000K	ø74mm x H55 mm
2	AR70-7-7W	7	7W	AC85-265V	30°	3000K / 4000K / 6000K	ø74mm x H55 mm
3	AR70-9-12W	9	12W	AC85-265V	30°	3000K / 6000K	ø74mm x H55 mm
4	AR70-12-12W	12	12W	AC85-265V	30°	3000K / 6000K	ø74mm x H55 mm

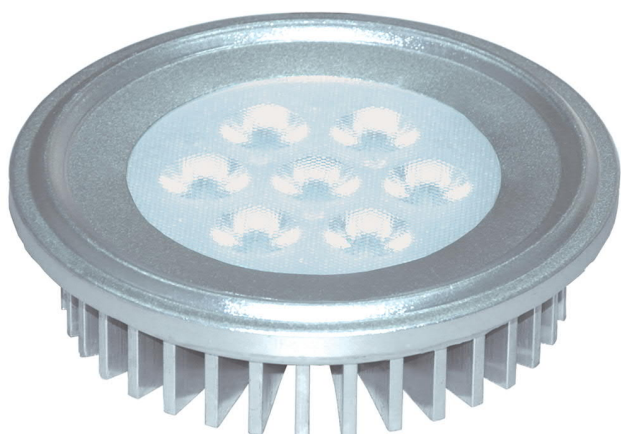

品名(Product Name) : LED AR111
型號(Model No.) : AR111L-1-10W
LED 顆數(Number of LED) : 7 珠
功率(Wattage) : 10W
輸入電壓(Input Volt) : 110V-220V 全電壓
光束角度(Beam Angle) : 30°
色溫(Color Temp.) : 3000K / 4000K / 6000K
尺寸規格(Size) : Ø110 mm , H 37 mm

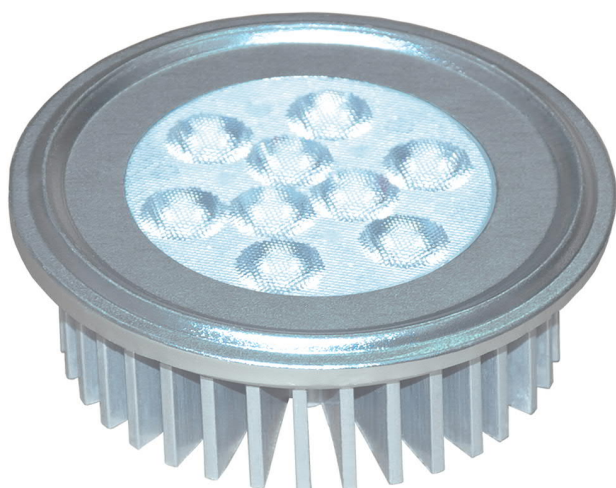

品名(Product Name) : LED AR111
型號(Model No.) : AR111L-1-12W
LED 顆數(Number of LED) : 9 珠
功率(Wattage) : 12W
輸入電壓(Input Volt) : 110V-220V 全電壓
光束角度(Beam Angle) : 30°
色溫(Color Temp.) : 3000K / 4000K / 6000K
尺寸規格(Size) : Ø110 mm , H 47 mm

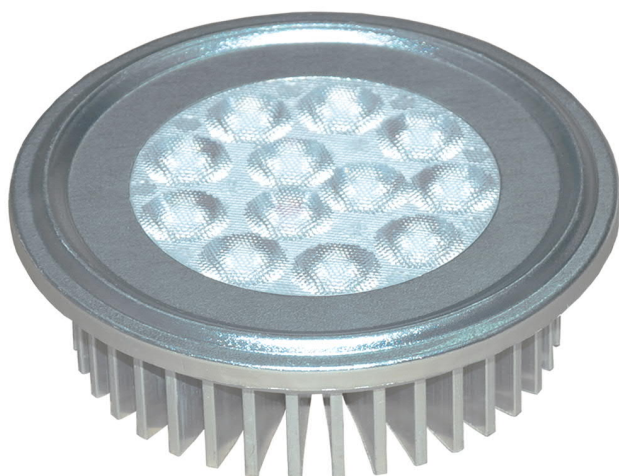

品名(Product Name) : LED AR111
型號(Model No.) : AR111L-1-18W
LED 顆數(Number of LED) : 12 珠
功率(Wattage) : 18W
輸入電壓(Input Volt) : 110V-220V 全電壓
光束角度(Beam Angle) : 30°
色溫(Color Temp.) : 3000K / 4000K / 6000K
尺寸規格(Size) : Ø110 mm , H 47 mm

LED 盒燈

使用LED AR111光源



7珠/10W



9珠/12W



12珠/18W

LED 盒燈-有邊框
With Frame



一燈



二燈



四燈



三燈

LED 盒燈-無邊框
Without Frame



一燈



二燈



四燈



三燈



- ◇ 使用光源：LED SMD。
- ◇ 材質：鋁質底盤+塑膠/玻璃燈罩。

- ◇ Light source：LED SMD.
- ◇ Materials：Aluminum base + acrylic front cover.



LMA-21-8-10 (10W)

LMA-21-8-15 (15W)

光源色溫 COLOR TEMP.：3000K / 5700K

外徑 DIA.：23CM 高度 HEIGHT：8CM



LMA-21-9-10 (10W)

LMA-21-9-15 (15W)

光源色溫 COLOR TEMP.：3000K / 5700K

外徑 DIA.：18.5CM 高度 HEIGHT：7CM



LMA-21-10-10 (10W)

LMA-21-10-15 (15W)

LMA-21-10-20 (20W)

LMA-21-10-30 (30W)

光源色溫 COLOR TEMP.：3000K / 5700K

外徑 DIA.：42CM 高度 HEIGHT：13CM



LMA-21-7-10 (10W)

LMA-21-7-15 (15W)

光源色溫 COLOR TEMP.：3000K / 5700K

外徑 DIA.：30CM 高度 HEIGHT：11CM



LMA-21-12-10 (10W)

LMA-21-12-15 (15W)

LMA-21-12-20 (20W)

LMA-21-12-30 (30W)

光源色溫 COLOR TEMP.：3000K / 5700K

外徑 DIA.：30CM 高度 HEIGHT：11CM

(本頁產品接受特殊功率訂製。VARIED WATTAGES OEM ACCEPTABLE.)

- ◇ 使用光源：LED SMD。
- ◇ 材質：鋁質底盤+塑膠/玻璃燈罩。

- ◇ Light source：LED SMD.
- ◇ Materials：Aluminum base + acrylic front cover.

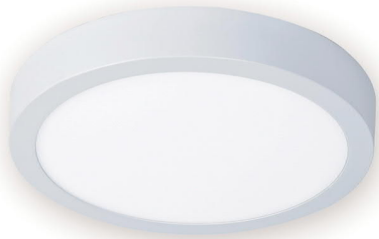

型號 MODEL NO.	燈具顏色 FRAME COLOR	LED 型式 LED TYPE	消耗功率 WATT	輸入電壓 INPUT VOLTAGE	光源色溫 COLOR TEMP.	燈具尺寸 SIZE (MM)
MK2-LMA-12-W	白 White	SMD 2835	12W	AC 85V-265V	3000K / 6000K	Ø175 x H30
MK2-LMA-18-W	白 White	SMD 2835	18W	AC 85V-265V	3000K / 6000K	Ø225 x H32
MK2-LMA-18-B	黑 Black	SMD 2835	18W	AC 85V-265V	3000K / 6000K	Ø225 x H32
MK2-LMA-24-W	白 White	SMD 2835	24W	AC 85V-265V	3000K / 6000K	Ø300 x H32
MK2-LMA-24-B	黑 Black	SMD 2835	24W	AC 85V-265V	3000K / 6000K	Ø300 x H32
MK2-LMA-36-W	白 White	SMD 2835	36W	AC 85V-265V	3000K / 6000K	Ø400 x H35

**滿月吸頂燈**

型號：CM-RM4442 (42W)
 CM-RM4448 (48W)
 CM-RM5660 (60W)

**星空吸頂燈**

型號：CM-RS4442 (42W)
 CM-RS4448 (48W)
 CM-RS5660 (60W)

**星鑽吸頂燈**

型號：CM-RD4442 (42W)
 CM-RD4448 (48W)
 CM-RD5660 (60W)

功能別	建議 坪數	功率	電壓	色溫	流明	演色性	產品尺寸 (MM)
壁切三段開關	3-5 坪	42W	100V-240V	3000K 4000K 6500K	3800LM 裸燈 4000LM 裸燈 4000LM 裸燈	RA80	440 X 102±5
多段調光調色 附遙控器	4-6 坪	48W	100V-240V	3000K I 6500K	5500LM 裸燈 5500LM 裸燈 5500LM 裸燈	RA80	440 X 102±5
多段調光調色 附遙控器	6-8 坪	60W	100V-240V	3000K I 6500K	6800LM 裸燈 7560LM 裸燈 6955LM 裸燈	RA80	560 X 105±5



顏色可選擇:

Colors for selection:



- ◇ 鋁擠型材質，輕巧精緻。
- ◇ 內置鏡面反射鋁板，反射效果佳。
- ◇ 可選用飛利浦 T5 LED 燈管。
- ◇ Aluminum extruded fixture with modern and stylish appearance.
- ◇ Aluminum mirror reflector installed for increasing the light.
- ◇ Philips T5 LED Tube is available for option.

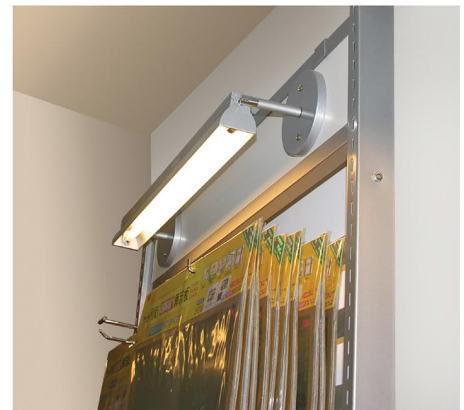

◇ 可加裝吊桿或改裝吸頂盤。

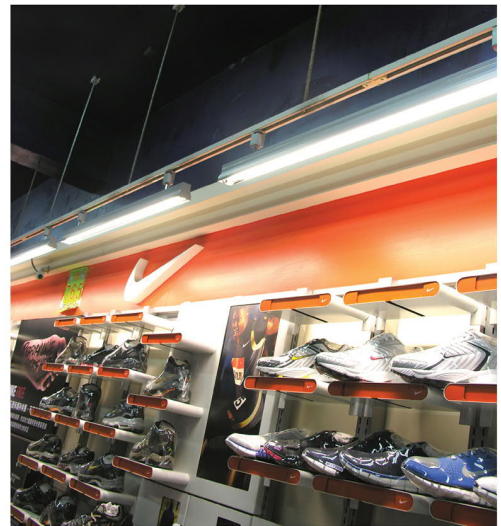

型號 Model No.	光源 Light Source	功率 Wattage	輸入電壓 Input Voltage	主體尺寸 Size (mm)		
				長(L)	寬(W)	高(H)
TK1-14	T5 日光燈管 T5 Fluorescent Tube	14W x 1	110V/220V	578	50	50
TK1-21	T5 日光燈管 T5 Fluorescent Tube	21W x 1	110V/220V	878	50	50
TK1-28	T5 日光燈管 T5 Fluorescent Tube	28W x 1	110V/220V	1178	50	50
TK1-L52081	T5 LED 燈管 T5 LED Tube	8W x 1	110V/220V	578	50	50
TK1-L54161	T5 LED 燈管 T5 LED Tube	16W x 1	110V/220V	1178	50	50



TK3 TYPE



TK4 TYPE

顏色可選擇:

Colors for selection:



銀色
Silver



白色
White



黑色
Black



金色
Gold

- ◇ 鋁擠型材質，輕巧精緻。
- ◇ 內置鏡面反射鋁板，反射效果佳。
- ◇ 可選用飛利浦 T5 LED 燈管。

- ◇ Aluminum extruded fixture with modern and stylish appearance.
- ◇ Aluminum mirror reflector installed for increasing the light.
- ◇ Philips T5 LED Tube is available for option.

型號 Model No.	光源 Light Source	功率 Wattage	輸入電壓 Input Voltage	主體尺寸 Size (mm)		
				長(L)	寬(W)	高(H)
TK3-14	T5 日光燈管 T5 Fluorescent Tube	14W x 1	110V/220V	578	50	58
TK3-21	T5 日光燈管 T5 Fluorescent Tube	21W x 1	110V/220V	878	50	58
TK3-28	T5 日光燈管 T5 Fluorescent Tube	28W x 1	110V/220V	1178	50	58
TK3-L52081	T5 LED 燈管 T5 LED Tube	8W x 1	110V/220V	578	50	58
TK3-L54161	T5 LED 燈管 T5 LED Tube	16W x 1	110V/220V	1178	50	58
TK4-142	T5 日光燈管 T5 Fluorescent Tube	14W x 2	110V/220V	578	93	90
TK4-212	T5 日光燈管 T5 Fluorescent Tube	21W x 2	110V/220V	878	93	90
TK4-282	T5 日光燈管 T5 Fluorescent Tube	28W x 2	110V/220V	1178	93	90
TK4-L52082	T5 LED 燈管 T5 LED Tube	8W x 2	110V/220V	578	93	90
TK4-L54162	T5 LED 燈管 T5 LED Tube	16W x 2	110V/220V	1178	93	90
TK4-L82101	T8 LED 燈管 T8 LED Tube	10W x 1	110V/220V	615	93	90
TK4-L84201	T8 LED 燈管 T8 LED Tube	20W x 1	110V/220V	1236	93	90

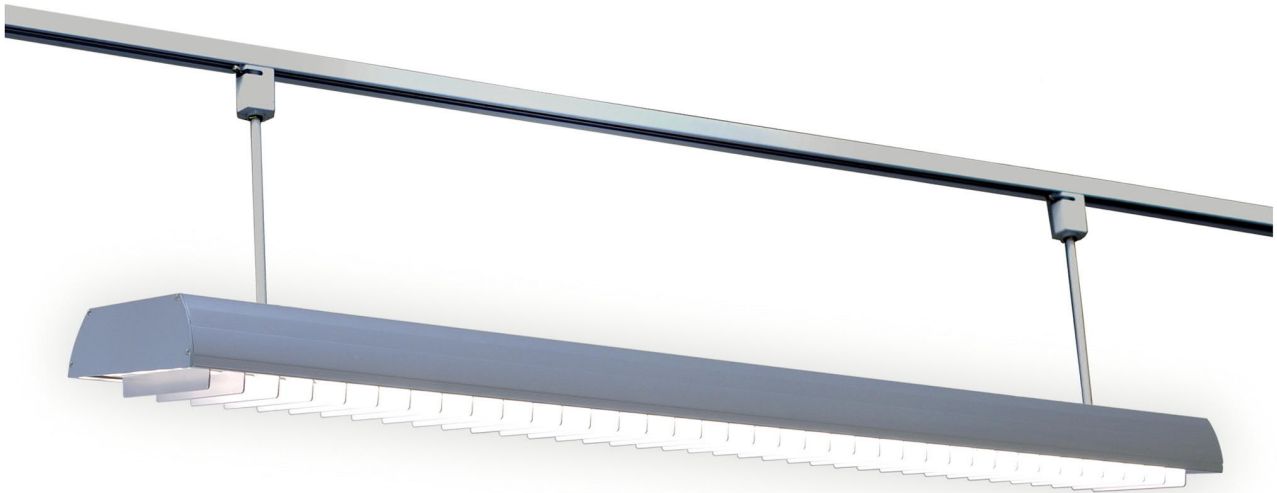

顏色可選擇:

Colors for selection:



- ◇ 鋁擠型材質，輕巧精緻
- ◇ 內置鏡面反射鋁板，反射效果佳。
- ◇ 防眩光格柵。
- ◇ T5 燈管/T8 燈管兩用。
- ◇ 可選用飛利浦 T5 LED 燈管。

- ◇ Aluminum extruded fixture with modern and stylish appearance.
- ◇ Aluminum mirror reflector installed for increasing the light.
- ◇ Louvers for decreasing the glare.
- ◇ T5 tube / T8 tube, dual purposes.
- ◇ Philips T5 LED Tube is available for option.

型號 Model No.	光源 Light Source	功率 Wattage	輸入電壓 Input Voltage	主體尺寸 Size (mm)		
				長(L)	寬(W)	高(H)
TK5-142	T5 日光燈管 T5 Fluorescent Tube	14W x 2	110V/220V	578	145	68
TK5-212	T5 日光燈管 T5 Fluorescent Tube	21W x 2	110V/220V	878	145	68
TK5-282	T5 日光燈管 T5 Fluorescent Tube	28W x 2	110V/220V	1178	145	68
TK5-L52082	T5 LED 燈管 T5 LED Tube	8W x 2	110V/220V	578	145	68
TK5-L54162	T5 LED 燈管 T5 LED Tube	16W x 2	110V/220V	1178	145	68
TK5-L82102	T8 LED 燈管 T8 LED Tube	10W x 2	110V/220V	615	145	68
TK5-L84202	T8 LED 燈管 T8 LED Tube	20W x 2	110V/220V	1236	145	68



型號 MODEL NO. : TKL-1113
電壓 VOLT: 100-240V
功率 WATT: 7W
光源色溫 COLOR TEMP.: 3000K / 4000K / 6000K
發光角度 BEAM ANGLE: 30°
外觀顏色 APPEARANCE COLOR : 白色 WHITE



型號 MODEL NO. : TKL-1114
電壓 VOLT: 100-240V
功率 WATT: 7W
光源色溫 COLOR TEMP.: 3000K / 6000K
發光角度 BEAM ANGLE: 30°
外觀顏色 APPEARANCE COLOR : 黑色 BLACK



型號 MODEL NO. : TKL-1117
電壓 VOLT: 85-265V
功率 WATT: 10W (7 珠)
光源色溫 COLOR TEMP.: 3000K / 4000K / 6000K
發光角度 BEAM ANGLE: 30°
外觀顏色 APPEARANCE COLOR : 白色 WHITE



型號 MODEL NO. : TKL-1118
電壓 VOLT: 85-265V
功率 WATT: 10W (7 珠)
光源色溫 COLOR TEMP.: 3000K / 4000K / 6000K
發光角度 BEAM ANGLE: 30°
外觀顏色 APPEARANCE COLOR : 黑色 BLACK



型號 MODEL NO. : TKL-1119
電壓 VOLT: 85-265V
功率 WATT: 12W (9 珠)
光源色溫 COLOR TEMP.: 3000K / 4000K / 6000K
發光角度 BEAM ANGLE: 30°
外觀顏色 APPEARANCE COLOR : 白色 WHITE



型號 MODEL NO. : TKL-1120
電壓 VOLT: 85-265V
功率 WATT: 12W (9 珠)
光源色溫 COLOR TEMP.: 3000K / 4000K / 6000K
發光角度 BEAM ANGLE: 30°
外觀顏色 APPEARANCE COLOR : 黑色 BLACK



型號 MODEL NO. : TKL-1121
電壓 VOLT: 85-265V
功率 WATT: 15W (12 珠)
光源色溫 COLOR TEMP.: 3000K / 4000K / 6000K
發光角度 BEAM ANGLE: 30°
外觀顏色 APPEARANCE COLOR : 白色 WHITE



型號 MODEL NO. : TKL-1122
電壓 VOLT: 85-265V
功率 WATT: 15W (12 珠)
光源色溫 COLOR TEMP.: 3000K / 4000K / 6000K
發光角度 BEAM ANGLE: 30°
外觀顏色 APPEARANCE COLOR : 黑色 BLACK



型號 MODEL NO. : TKL-1106
電壓 VOLT: 100-240V
功率 WATT: 9W
光源色溫 COLOR TEMP.: 3000K / 5700K
演色指數 CRI: 80
外觀顏色 APPEARANCE COLOR : 白色 WHITE



型號 MODEL NO. : TKL-1107
電壓 VOLT: 100-240V
功率 WATT: 12W
光源色溫 COLOR TEMP.: 3000K / 5700K
演色指數 CRI: 80
外觀顏色 APPEARANCE COLOR : 白色 WHITE

LED 照明燈具 - 軌道燈 - COB型
LED LUMINAIRE - TRACK LAMP - COB TYPE



型號 MODEL NO. : TKL-1201-7W-W
電壓 VOLT: 85-260V
功率 WATT: 7W
光束角度 BEAM ANGLE: 38°
光源色溫 COLOR TEMP.: 3000K / 6000K
演色指數 CRI: 80
外觀顏色 APPEARANCE COLOR : 白色 WHITE
尺寸 SIZE(MM): Ø60x100, H158xW90



型號 MODEL NO. : TKL-1202-7W-B
電壓 VOLT: 85-260V
功率 WATT: 7W
光束角度 BEAM ANGLE: 38°
光源色溫 COLOR TEMP.: 3000K / 6000K
演色指數 CRI: 80
外觀顏色 APPEARANCE COLOR : 黑色 BLACK
尺寸 SIZE(MM): Ø60x100, H158xW90



型號 MODEL NO. : TKL-1203-12W-W
電壓 VOLT: 85-260V
功率 WATT: 12W
光束角度 BEAM ANGLE: 38°
光源色溫 COLOR TEMP.: 3000K / 6000K
演色指數 CRI: 80
外觀顏色 APPEARANCE COLOR : 白色 WHITE
尺寸 SIZE(MM): Ø80x120, H210xW140



型號 MODEL NO. : TKL-1204-12W-B
電壓 VOLT: 85-260V
功率 WATT: 12W
光束角度 BEAM ANGLE: 38°
光源色溫 COLOR TEMP.: 3000K / 6000K
演色指數 CRI: 80
外觀顏色 APPEARANCE COLOR : 黑色 BLACK
尺寸 SIZE(MM): Ø80x120, H210xW140



型號 MODEL NO. : TKL-1205-15W-W
電壓 VOLT: 85-260V
功率 WATT: 15W
光束角度 BEAM ANGLE: 38°
光源色溫 COLOR TEMP.: 3000K / 6000K
演色指數 CRI: 80
外觀顏色 APPEARANCE COLOR : 白色 WHITE
尺寸 SIZE(MM): Ø90x140, H250xW176



型號 MODEL NO. : TKL-1206-15W-B
電壓 VOLT: 85-260V
功率 WATT: 15W
光束角度 BEAM ANGLE: 38°
光源色溫 COLOR TEMP.: 3000K / 6000K
演色指數 CRI: 80
外觀顏色 APPEARANCE COLOR : 黑色 BLACK
尺寸 SIZE(MM): Ø90x140, H250xW176



型號 MODEL NO. : TKL-1207-20W-W
電壓 VOLT: 85-260V
功率 WATT: 20W
光束角度 BEAM ANGLE: 38°
光源色溫 COLOR TEMP.: 3000K / 4000K / 6000K
演色指數 CRI: 80
外觀顏色 APPEARANCE COLOR : 白色 WHITE
尺寸 SIZE(MM): Ø90 x W135 x H140



型號 MODEL NO. : TKL-1207-20W-B
電壓 VOLT: 85-260V
功率 WATT: 20W
光束角度 BEAM ANGLE: 38°
光源色溫 COLOR TEMP.: 3000K / 4000K / 6000K
演色指數 CRI: 80
外觀顏色 APPEARANCE COLOR : 黑色 BLACK
尺寸 SIZE(MM): Ø90 x W135 x H140



型號 MODEL NO. : TKL-1209-30W-W
電壓 VOLT: 85-260V
功率 WATT: 30W
光束角度 BEAM ANGLE: 38°
光源色溫 COLOR TEMP.: 3000K / 6000K
演色指數 CRI: 80
外觀顏色 APPEARANCE COLOR : 白色 WHITE
尺寸 SIZE(MM): Ø90x140, H250xW176



型號 MODEL NO. : TKL-1210-30W-B
電壓 VOLT: 85-260V
功率 WATT: 30W
光束角度 BEAM ANGLE: 38°
光源色溫 COLOR TEMP.: 3000K / 6000K
演色指數 CRI: 80
外觀顏色 APPEARANCE COLOR : 黑色 BLACK
尺寸 SIZE(MM): Ø90x140, H250xW176

LED碗形軌道燈



型號	TKL-AR07-2W(白) TKL-AR07-2B(黑)	TKL-AR09-2W(白) TKL-AR09-2B(黑)	TKL-AR12-2W(白) TKL-AR12-2B(黑)	TKL-AR15-2W(白) TKL-AR15-2B(黑)
光源	LED-7 珠	LED-9 珠	LED-12 珠	LED-15 珠
功率	10W	12W	15W	18W
輸入電壓	AC85V-265V	AC85V-265V	AC85V-265V	AC85V-265V
光通量(lm)	900	1080	1350	1620
發光角度	30°	30°	30°	30°
色溫(K)	3000/4000/6000	3000/4000/6000	3000/4000/6000	3000/6000
材質	鐵材烤漆	鐵材烤漆	鐵材烤漆	鐵材烤漆
尺寸(mm)	Ø125Xw75xH210	Ø125Xw75xH210	Ø125Xw75xH210	Ø125Xw75xH210

LED碗形吸頂燈



型號	CM-AR07-2W(白) CM-AR07-2B(黑)	CM-AR09-2W(白) CM-AR09-2B(黑)	CM-AR12-2W(白) CM-AR12-2B(黑)	CM-AR15-2W(白) CM-AR15-2B(黑)
光源	LED-7 珠	LED-9 珠	LED-12 珠	LED-15 珠
功率	10W	12W	15W	18W
輸入電壓	AC85V-265V	AC85V-265V	AC85V-265V	AC85V-265V
光通量(lm)	900	1080	1350	1620
發光角度	30°	30°	30°	30°
色溫(K)	3000/4000/6000	3000/6000	3000/4000/6000	3000/4000/6000
材質	鐵材烤漆	鐵材烤漆	鐵材烤漆	鐵材烤漆
尺寸(mm)	Ø115Xw75xH210	Ø115Xw75xH210	Ø115Xw75xH210	Ø115Xw75xH210



- ◇ 鋁擠型材質，輕巧精緻。
- ◇ 較大之燈管槽，可使燈光反射效果更佳。
- ◇ 可選用飛利浦 T5 LED 燈管。
- ◇ Aluminum extruded fixture with modern and stylish appearance.
- ◇ Large laying space of tube makes more light radiation.
- ◇ Philips T5 LED Tube is available for option.

型號 Model No.	遮罩 Front Cover	光源 Light Source	功率 Wattage	輸入電壓 Input Voltage	主體尺寸 Size (mm)		
					長(L)	寬(W)	高(H)
LC-8	無 No	T5 日光燈管 T5 Fluorescent Tube	8W x 1	110V/220V	318	64	28
LC-14	無 No	T5 日光燈管 T5 Fluorescent Tube	14W x 1	110V/220V	578	64	28
LC-21	無 No	T5 日光燈管 T5 Fluorescent Tube	21W x 1	110V/220V	878	64	28
LC-28	無 No	T5 日光燈管 T5 Fluorescent Tube	28W x 1	110V/220V	1178	64	28
LC-L52081	無 No	T5 LED 燈管 T5 LED Tube	8W x 1	110V/220V	578	64	28
LC-L54161	無 No	T5 LED 燈管 T5 LED Tube	16W x 1	110V/220V	1178	64	28
LC-8C	有 Yes	T5 日光燈管 T5 Fluorescent Tube	8W x 1	110V/220V	318	64	28
LC-14C	有 Yes	T5 日光燈管 T5 Fluorescent Tube	14W x 1	110V/220V	578	64	28
LC-21C	有 Yes	T5 日光燈管 T5 Fluorescent Tube	21W x 1	110V/220V	878	64	28
LC-28C	有 Yes	T5 日光燈管 T5 Fluorescent Tube	28W x 1	110V/220V	1178	64	28
LC-L52081C	有 Yes	T5 LED 燈管 T5 LED Tube	8W x 1	110V/220V	578	64	28
LC-L54161C	有 Yes	T5 LED 燈管 T5 LED Tube	16W x 1	110V/220V	1178	64	28



LED 投光燈

材質 Material : 鋁材 Aliminum

輸入電壓 : AC 85 – 265V

色溫 : 3000K、6000K

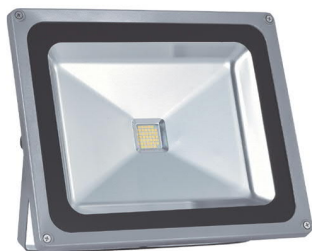

型號(Model No.) : MK-FD1-20W
功率(Wattage) : 20W
光效(Lm/W) : 110 Lm/W
光束角度(Beam Angle) : 120°
尺寸(Size) : L180xW140xH95 mm
防水等級(IP Code) : IP65

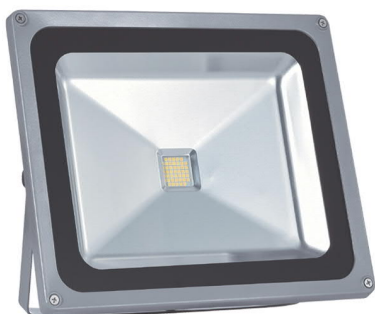

型號(Model No.) : MK-FD1-30W
功率(Wattage) : 30W
光效(Lm/W) : 110 Lm/W
光束角度(Beam Angle) : 120°
尺寸(Size) : L220xW180xH101 mm
防水等級(IP Code) : IP65

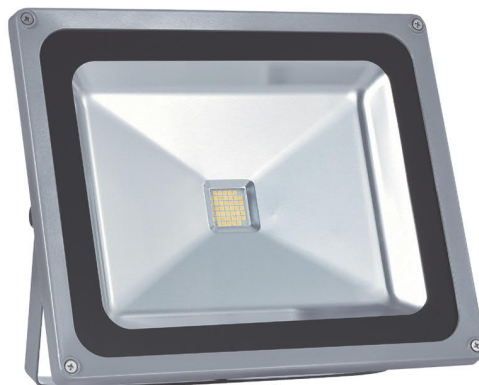

型號(Model No.) : MK-FD1-50W
功率(Wattage) : 50W
光效(Lm/W) : 110 Lm/W
光束角度(Beam Angle) : 120°
尺寸(Size) : L285xW235xH125 mm
防水等級(IP Code) : IP65

LED 投光燈-感應式 AUTO SENSOR TYPE

人來開燈 人走關燈



型號(Model No.) : MK-FD1A-20W
功率(Wattage) : 20W
光效(Lm/W) : 110 Lm/W
光束角度(Beam Angle) : 120°
尺寸(Size) : L180xW140xH95 mm
防水等級(IP Code) : IP65



型號(Model No.) : MK-FD1A-30W
功率(Wattage) : 30W
光效(Lm/W) : 110 Lm/W
光束角度(Beam Angle) : 120°
尺寸(Size) : L220xW180xH101 mm
防水等級(IP Code) : IP65



型號(Model No.) : MK-FD1A-50W
功率(Wattage) : 50W
光效(Lm/W) : 110 Lm/W
光束角度(Beam Angle) : 120°
尺寸(Size) : L285xW235xH125 mm
防水等級(IP Code) : IP65



- ◇ 防水等級達 IP65，可適用於室外場所。
- ◇ 適用於室內、室外場所、挑高廠房、購物中心、展覽場所、無塵室、倉儲、體育場館、活動中心、地下室、停車場、室內外天車、.....等照明。
- ◇ Waterproof to IP65, suitable for outdoor use.
- ◇ Suitable for indoor and outdoor places, high-rise workshops, shopping malls, exhibition halls, clean rooms, warehouses, stadiums, activity centers, basements, parking lots, indoor and outdoor cranes, etc.

型號 Model No.	功率 Watt	輸入電壓 Input Voltage	色溫 Color Temp.	防水等級 IP Code	光通量 Lumen	光效 Lm / W	尺寸 Size
HBU-100W2	100W	AC 86-265V	4000K / 6000K	IP65	11,000 Lm	> 110 Lm/W	Ø315mm x H175mm
HBU-150W2	150W	AC 86-265V	4000K / 6000K	IP65	16,500 Lm	> 110 Lm/W	Ø365mm x H185mm
HBU-200W1	200W	AC 86-265V	5500K±5%	IP65	22,000 Lm	> 110 Lm/W	Ø430mm x H185mm

LED 投光天井燈

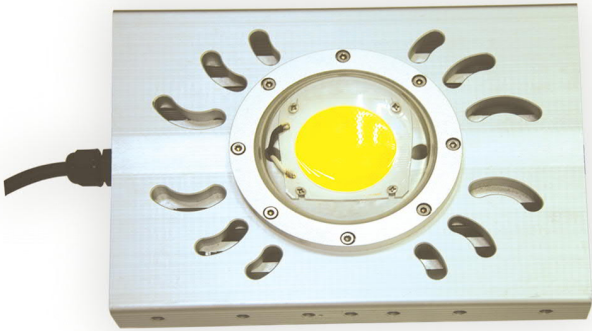

單燈 Single

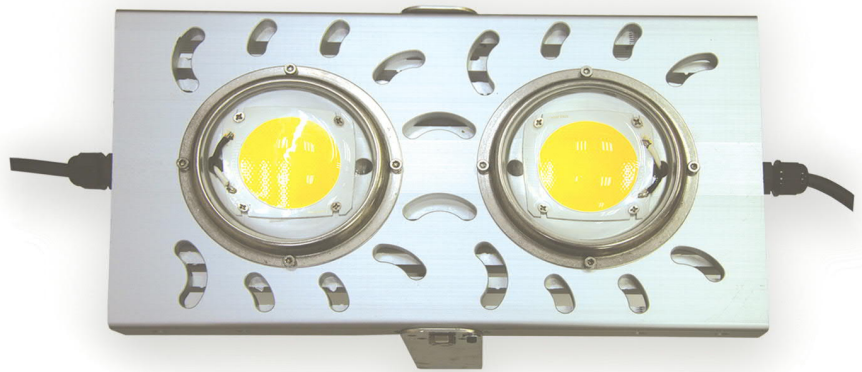

雙燈 Double

◇ 散熱效果：

1. 台灣製造鋁合金燈具。採用優質鋁材，燈具散熱效果良好。
2. 燈具的散熱設計為特殊設計，散熱效果比一般燈具良好。
3. 採用 COB 覆晶(倒裝)晶片，直接將 LED 覆晶在金屬核心電路板上，具有較佳的散熱特性，可以把 LED 產生的熱，透過電路板傳導到散熱器與外殼。

◇ 無頻閃：良好的電源無頻閃。

◇ 電源：本產品使用台灣明緯電源。

◇ 較低之消耗功率：良好的散熱、良好的 LED 晶片、良好的電源，降低功率的消耗。

◇ 功率型式：100W，150W，200W，320W。

◇ 台灣設計，台灣開模，台灣生產。

型號 Model No.	燈數 Lamp Q'ty	功率 Watt	電壓 Volt	色溫 Color Temp	防護等級 IP Code	光通量 Lumen	光效 Lm / W	尺寸 (mm)		
								長 (L)	寬 (W)	高 (H)
GD-100-W	單燈 Single	100W	100-240V	5700K	IP68	13653	136.5	250	190	53
GD-150-W	單燈 Single	150W	100-240V	5700K	IP68	20010	133.4	250	190	53
GD-200-W	單燈 Single	200W	100-240V	5700K	IP68	26801	130.5	250	190	53
GD-200-W-2	雙燈 Double	200W	100-240V	5700K	IP68	26904	134.5	350	190	53
GD-320-W-2	雙燈 Double	320W	100-240V	5700K	IP68	42027	132.9	350	190	53

超級亮 光效 190Lm/W 總流明 19000Lm



高亮度 + 防水 + 防鹽霧

- 通過 CNS 驗證
- 通過 CNS8886 RN10 鹽霧測試
- 通過 IP68 防塵防水測試

產品特色：

- ◆ 採用 E39/E40，不須更換燈具，安裝簡單，更換方便。
- ◆ 高發光效率，光效 190Lm/W 以上，總光通量 >19000Lm。
- ◆ 體積小(162*92*256mm)，重量輕(<1.5KG)。
- ◆ 光源模組採用開放式防水設計，搭配抗酸、鹼、鹽高科技奈米防水技術，防護等級可達 IP68，更通過鹽霧加醋酸測試(CNS 8886 RN10)，適合空氣潮溼與鹽份高的海邊環境與溫泉區使用。
- ◆ 特殊專利設計高效散熱鰭片，提高燈具效能，延長使用壽命。

適用場所：

海邊環境、溫泉區、游泳池、室內球場、室內運動場、倉庫、物流中心、大賣場、挑高建築、挑高廠房等。

型號 Model No.	功率 Wattage	輸入電壓 Input Voltage	光通量 Lumen	光效 Lm/W	尺寸 Size (mm)
WTF-L01-100CAA1	100W	110V/240V	>19000	>190	162 x 92 x 256

無塵燈-淚滴型 TEARDROP TYPE



- ◇ 材質規格
本體：鋁擠成型，陽極處理。
燈罩：PC 成型。
- ◇ 使用光源：LED T8 燈管。

- ◇ Material
Lamp Body: Aluminum extrusion.
Lampshade: PC molding.
- ◇ Light Source: LED T8 Tube.

型號 Model No.	使用燈管 Tube Type	功率 Wattage	輸入電壓 Input Voltage	主體尺寸 Size (mm)		
				長(L)	寬(W)	高(H)
CRTD-82-10	LED T8	10W	110V/220V	650	50	93
CRTD-84-20	LED T8	20W	110V/220V	1250	50	93

無塵燈-上掀型 OPEN-UP TYPE



- 材質規格
- ◇ 本體：磨光鋼板白色烤漆+防腐蝕處理。
 - ◇ 燈罩：5 mm 強化玻璃。
- 規格
- ◇ 使用光源：配合 T8 / T5 燈管長度使用。
 - ◇ 安裝方式：配合無塵室 T-BAR 架。
 - ◇ 荷重：100 KGS 以上。
- 說明
- ◇ 後掀式兩邊開啓，維修方便，不影響廠區作業。
 - ◇ 燈具長邊兩側有固定把手以利搬運。
 - ◇ 防水接頭可連接燈具內部快插式 3P 端子座。

- MATERIALS
- ◇ Lamp Body: Steel (SPCC) white coating, + anti-corrosion treatment.
 - ◇ Lamp cover: 5 mm tempered glass.
- SPECIFICATIONS
- ◇ Light Source: LED T5 / T8 Tube.
 - ◇ Installation method: match the clean room T-BAR lamp frame.
 - ◇ Load: more than 100 KGS.
- DESCRIPTION
- ◇ The rear sill type is opened to both sides, which is convenient for maintenance and does not affect the operation of the plant.
 - ◇ Handles on both sides of the long side of the lamp for easy handling.
 - ◇ Waterproof connector for connection to the plug-in 3P terminal block inside the fixture

型號 Model No.	使用燈管 Tube Type	功率 Wattage	輸入電壓 Input Voltage	主體尺寸 Size (mm)		
				長(L)	寬(W)	高(H)
CROU-543	LED T5	16W x 3	110V/220V	1170	570	105
CROU-843	LED T8	20W x 3	110V/220V	1221	600	120

人來自動開燈，人走自動關燈，方便又省電，絕不浪費電力，為您節省更多電費！
沒有人人在的時候還開燈就是『浪費』，安裝此燈具，省下的電費不是只有幾倍，而是幾十倍。
Auto turn on when man inside the detection scope, auto turn off when outside the detection scope. Saving electricity and saving money.

LED微波雷達感應燈管

LED MICROWAVE RADAR SENSOR TUBE



適用場所：樓梯間、電梯間、地下室、停車場、.....等。

Place of application : staircase, emergency exit, elevator room, basement, underground parking lot,.....etc.

型號 Model No.	燈管型式 Tube Type	感應方式 Induction Method	燈光開滅 Light ON/OFF	功率 Wattage	輸入電壓 Input Voltage	燈管長度 Tube Length
AF8-4100965-U1	T8	微波雷達 Microwave Radar	全開全滅 100% ON/OFF	10W	110V/220V	59 cm
AF8-4201865-U1	T8	微波雷達 Microwave Radar	全開全滅 100% ON/OFF	20W	110V/220V	120 cm
AS8-4100965-U1	T8	微波雷達 Microwave Radar	有人時 100%，無人時 30% ON : 100% , OFF : 30%	10W	110V/220V	59 cm
AS8-4201865-U1	T8	微波雷達 Microwave Radar	有人時 100%，無人時 30% ON : 100% , OFF : 30%	20W	110V/220V	120 cm

LED雷達感應嵌燈

LED RADAR SENSOR RECESSED LAMP



- ◇ 型號：ASRE-1512
- ◇ 輸入電壓：100V-240V AC。
- ◇ 額定功率：12W。
- ◇ 燈光色溫：3000K(黃光)，6000K(白光)。
- ◇ 嵌入孔直徑：15 公分。
- ◇ 感應距離：3~5 公尺。
- ◇ 適用場所：玄關門口、茶水間、廁所、樓梯間、電梯門口等。
- ◇ Model No. : ASRE-1512.
- ◇ Input Voltage : 100V-240V AC.
- ◇ Wattage : 12W.
- ◇ Color Temp. : 3000K, 6000K.
- ◇ Embedded hole diameter : 15 cm.
- ◇ Sensing Distance : 3~5 meter.
- ◇ Applicable places: Entrance door, tea room, toilet, stairwell, elevator door, etc.

LED微波自動感應燈泡

LED MICROWAVE AUTO SENSOR BULB



- ◇ 型號：MAB-10W
- ◇ 輸入電壓：100V-277V AC。
- ◇ 額定功率：10W。
- ◇ 燈光色溫：3000K(黃光)，6000K(白光)。
- ◇ 感應距離：3~5 公尺。
- ◇ 無 UV/IR 光輻射。
- ◇ 符合綠色節能與 ROHS 規範。
- ◇ 適用燈座：E27。
- ◇ 適用場所：停車場、走廊、茶水間、廁所、樓梯間、電梯門口等。
- ◇ Model No. : MAB-10W.
- ◇ Input Voltage : 100V-277V AC.
- ◇ Wattage : 10W.
- ◇ Color Temp. : 3000K, 6000K.
- ◇ Sensing Distance : 3~5 meter.
- ◇ No UV/IR radiation.
- ◇ Comply with green energy saving and ROHS specifications.
- ◇ Socket : E27.
- ◇ Applicable places: parking lot, corridor, tea room, toilet, stairwell, elevator door, etc.



- ◇ 防水、防塵、防腐蝕。
- ◇ 防護系數：IP65。
- ◇ 使用光源：LED T8 燈管。
- ◇ Proof：Water、dust、rust proof.
- ◇ IP：65.
- ◇ Light Source：LED T8 tube.

型號 Model No.	光源 Light Source	功率 Wattage	輸入電壓 Input Voltage	主體尺寸 Size (mm)		
				長(L)	寬(W)	高(H)
WP-L82101	T8 LED 燈管 T8 LED Tube	10W x 1	110V/220V	665	70	84
WP-L84201	T8 LED 燈管 T8 LED Tube	20W x 1	110V/220V	1275	70	84
WP-L82102	T8 LED 燈管 T8 LED Tube	10W x 2	110V/220V	665	95	84
WP-L84202	T8 LED 燈管 T8 LED Tube	20W x 2	110V/220V	1275	95	84



- ◇ 品名：筒燈
- ◇ 型號：
 - DL-BB-130-B (黑色)
 - DL-BB-130-W (白色)
- ◇ 尺寸(mm)：Ø130 x 150
- ◇ 適用光源：LED 球泡、螺旋省電燈泡
- ◇ 燈頭：E27
- ◇ Product Name：Downlight Lamp
- ◇ Model Name：
 - DL-BB-130 (Black)
 - DL-BB-130-W (White)
- ◇ Size(mm)：Ø130 x 150
- ◇ Suitable light source：LED Bulb、Spiral Lamp
- ◇ Socket：E27



- ◇ 品名：筒燈
- ◇ 型號：
 - DL-BB-190-B (黑色)
 - DL-BB-190-W (白色)
- ◇ 尺寸(mm)：Ø190 x 190
- ◇ 適用光源：LED 球泡、螺旋省電燈泡
- ◇ 燈頭：E27
- ◇ Product Name：Downlight Lamp
- ◇ Model Name：
 - DL-BB-190-B (Black)
 - DL-BB-190-W (White)
- ◇ Size(mm)：Ø190 x 190
- ◇ Suitable light source：LED Bulb、Spiral Lamp
- ◇ Socket：E27



- ◇ 品名：筒燈
- ◇ 型號：
 - DL-PAR-190-B (黑色)
 - DL-PAR-190-W (白色)
- ◇ 尺寸(mm)：Ø190 x 190
- ◇ 適用光源：PAR30、PAR38
- ◇ 燈頭：E27
- ◇ Product Name：Downlight Lamp
- ◇ Model Name：
 - DL-PAR-190-B (Black)
 - DL-PAR-190-W (White)
- ◇ Size(mm)：Ø190 x 190
- ◇ Suitable light source：PAR30, PAR38
- ◇ Socket：E27



- ◇ 品名：筒燈
- ◇ 型號：
 - DL-AR111-168-B (黑色)
 - DL-AR111-168-W (白色)
- ◇ 尺寸(mm)：Ø168 x 175
- ◇ 適用光源：AR111
- ◇ Product Name：Downlight Lamp
- ◇ Model Name：
 - DL-AR111-168-B (Black)
 - DL-AR111-168-W (White)
- ◇ Size(mm)：Ø168 x 175
- ◇ Suitable light source：AR111



CNS安規測試通過

燈管要夠亮才有用，不亮的燈管會傷害視力。

堅持高流明

堅持高光效

堅持高 CP 值

- ✧ 使用高光效 LED。消耗較少的電力，可以發出更亮的光。發光效率高，降低功耗，節省電費。
- ✧ 光通量大，燈光夠亮，不會傷害視力。節省用電。
- ✧ 使用高功率因數驅動器。高功率因數可以降低功耗。節能減碳，滿足低碳環保要求。
- ✧ 價格便宜，CP 值高。
- ✧ Use high luminous efficiency LED. Consume less electricity, but emit a brighter light. High lumen-efficiency, reduce power consumption, saving electricity costs.
- ✧ High lumen, the light is bright enough; it will not hurt the eyesight.
- ✧ Use the high power factor Driver which can reduce the power consumption. Energy saving and carbon reduction, meet the requirements of low-carbon environmental protection.
- ✧ Cheap price, high CP value.

型號 Model No.	燈管材質 Tube Materials	燈管口徑 Diameter	名義功率 Nominal Wattage	輸入電壓 Input Voltage	功率因素 Power Factor	燈光色溫 Color Temp.	光通量 Lumen	燈管長度 Tube Length
LT8-2101061U	玻纖管/玻璃管	T8	10W	110-220V	>0.90	6100K	>1000 LM	58 cm
LT8-2101040U	玻纖管/玻璃管	T8	10W	110-220V	>0.90	4000K	>1000 LM	58 cm
LT8-2101030U	玻纖管/玻璃管	T8	10W	110-220V	>0.90	3000K	>1000 LM	58 cm
LT8-4202061U	玻纖管/玻璃管	T8	20W	110-220V	>0.90	6100K	>2000 LM	120 cm
LT8-4202040U	玻纖管/玻璃管	T8	20W	110-220V	>0.90	4000K	>2000 LM	120 cm
LT8-4202030U	玻纖管/玻璃管	T8	20W	110-220V	>0.90	3000K	>2000 LM	120 cm

其它規格或款式，請洽本公司。

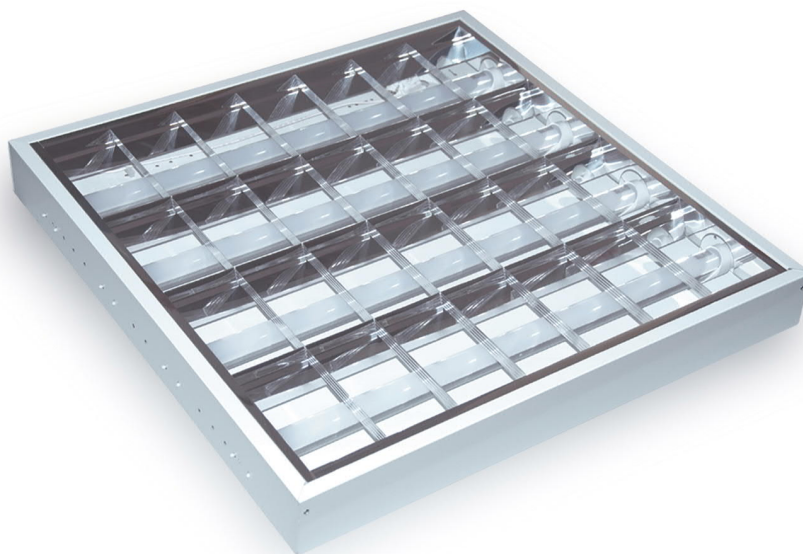

- ◇ 吸頂與嵌入兩用型。
- ◇ 磨光鋼板白色烤漆 + 鏡面反射鋁板。
- ◇ 可選用 T5 燈管或 T8 燈管。
- ◇ 使用 LED T8 燈管時，可選用單端供電或雙端供電。
- ◇ Ceiling mounted and embedded dual-purpose type.
- ◇ Steel (SPCC) coating fixture + aluminum mirror reflector.
- ◇ T5 type or T8 type is available for option.
- ◇ Single-ended or dual-ended power supply is available when using LED T8 lamps.

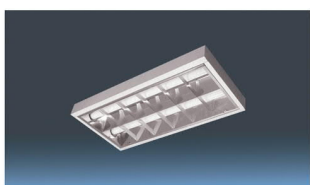

1 尺 x 2 尺

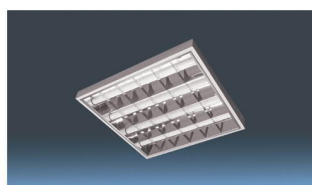

2 尺 x 2 尺

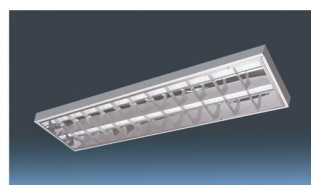

1 尺 x 4 尺



2 尺 x 4 尺

型號 Model No.	光源 Light Source	電壓 Voltage	功率 Wattage	燈光色溫 Color Temperature	主體尺寸 Size (mm)		
					長(L)	寬(W)	高(H)
T8-212ML	T8 LED	110V-220V	10W x 2	3000K/4000K/6100K	600	300	65
T8-223ML	T8 LED	110V-220V	10W x 3	3000K/4000K/6100K	600	600	65
T8-224ML	T8 LED	110V-220V	10W x 4	3000K/4000K/6100K	600	600	65
T8-411ML	T8 LED	110V-220V	20W x 1	3000K/4000K/6100K	1220	190	65
T8-412ML	T8 LED	110V-220V	20W x 2	3000K/4000K/6100K	1220	300	65
T8-423ML	T8 LED	110V-220V	20W x 3	3000K/4000K/6100K	1220	600	65
T8-424ML	T8 LED	110V-220V	20W x 4	3000K/4000K/6100K	1220	600	65



- ◇ 磨光鋼板白色烤漆。
- ◇ 使用 T8 LED 燈管。
- ◇ 可選用半鋁半塑 LED 燈管，散熱良好，燈管使用壽命長。
- ◇ Steel (SPCC) coating fixture.
- ◇ Apply the T8 LED tubes.
- ◇ Aluminum type of LED tube is available for option, which provides best heat dissipation and longest lifespan.

型 號 Model No.	光 源 Light Source	功 率 Wattage	主體尺寸 Size (mm)		
			長(L)	寬(W)	高(H)
MT-5-L82101	T8 LED	10W x 1	623	110	40
MT-5-L84201	T8 LED	20W x 1	1245	110	40
MT-5-L82102	T8 LED	10W x 2	623	137	43
MT-5-L84202	T8 LED	20W x 2	1245	137	43

白色烤漆型
White Coating Reflector Type



鏡面鋁反光板型
Aluminum Mirror Reflector Type

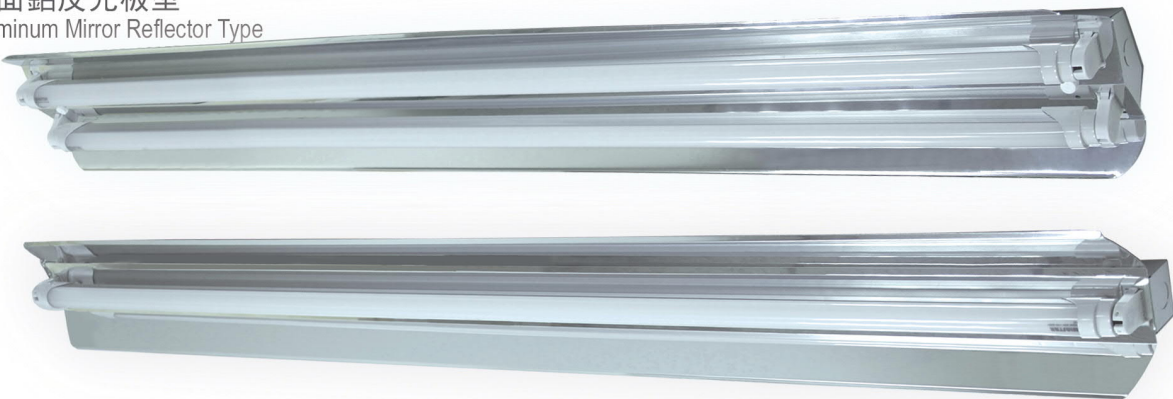

- ◇ 主體：磨光鋼板白色烤漆。
- ◇ 反光板：
磨光鋼板白色烤漆反光板。
鏡面鋁反光板。
- ◇ 鏡面鋁反光板可增加反光效果。
- ◇ 適用 T8 LED 燈管。

- ◇ Main Body : Steel (SPCC) white coating.
- ◇ Reflector :
Steel (SPCC) white coating reflector.
Aluminum mirror reflector.
- ◇ Aluminum mirror reflector can increase the reflection effect.
- ◇ Use T8 LED Tube.

型號 Model No.	型式 Type	光源 Light Source	功率 Wattage	輸入電壓 Input Voltage	主體尺寸 Size (mm)		
					長(L)	寬(W)	高(H)
WA-L82101	白色烤漆 White Coating	T8 LED 燈管 T8 LED Tube	10W x 1	110V/220V	615	140	72
WA-L84201	白色烤漆 White Coating	T8 LED 燈管 T8 LED Tube	20W x 1	110V/220V	1235	140	72
WA-L82102	白色烤漆 White Coating	T8 LED 燈管 T8 LED Tube	10W x 2	110V/220V	615	170	85
WA-L84202	白色烤漆 White Coating	T8 LED 燈管 T8 LED Tube	20W x 2	110V/220V	1235	170	85
WA-L82101R	鏡面鋁反光板 Aluminum Reflector	T8 LED 燈管 T8 LED Tube	10W x 1	110V/220V	615	140	72
WA-L84201R	鏡面鋁反光板 Aluminum Reflector	T8 LED 燈管 T8 LED Tube	20W x 1	110V/220V	1235	140	72
WA-L82102R	鏡面鋁反光板 Aluminum Reflector	T8 LED 燈管 T8 LED Tube	10W x 2	110V/220V	615	170	85
WA-L84202R	鏡面鋁反光板 Aluminum Reflector	T8 LED 燈管 T8 LED Tube	20W x 2	110V/220V	1235	170	85



吸頂框 CEILING FRAME



不再擔心沒有天花板可裝燈

No longer worry about no ceilings to hold lights

- ✧ 吸附於屋頂下，燈具由框架側邊滑入。
- ✧ 適用燈具：LED 平板燈。
- ✧ Adsorbed under the indoor roof, the lamps slide in from the side of the frame.
- ✧ Applicable lamps: LED panel lamp.

型號 Model No.	主體尺寸 Size (mm)		
	長(L)	寬(W)	高(H)
CF-21	605	305	42
CF-22	605	605	42
CF-41	1205	305	42
CF-42	1205	605	42

軌道條 TRACK RAIL



- ✧ 台灣製造，品質優良。
- ✧ 顏色：黑色，白色。
- ✧ 尺寸(長度)：1M，1.5M，2M，3M。

- ✧ Made in Taiwan, good quality.
- ✧ Color : Black, White.
- ✧ Size (Length): 1M, 1.5M, 2M, 3M.

軌道頭 Adapter



台灣製造 品質可靠
Made in Taiwan, reliable quality

吸頂盒(天房盒) CEILING BOX



台灣製造 品質可靠
Made in Taiwan, reliable quality

鋼絲(線) STEEL WIRE

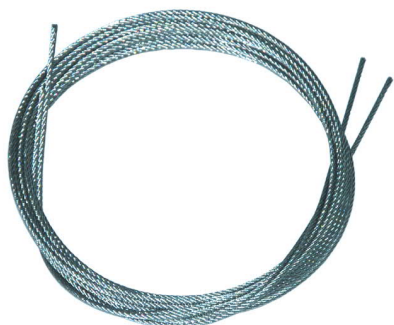

Ø1.5 mm
台灣製造 品質可靠
Made in Taiwan, reliable quality

線扣 WIRE HOLDER



台灣製造 品質可靠
Made in Taiwan, reliable quality

UVC紫外線殺菌器

使用波長 253.7nm 之 UV-C 殺菌。

紫外光之殺菌種類

有細胞的病毒與細菌皆可殺死：紫外線殺菌光可殺死冠狀病毒、腸病毒、流感病毒、大腸菌、赤痢菌、傷寒菌、葡萄球菌、結核菌、香港腳黴菌……等。亦可殺死塵蟎、跳蚤、蝨子、水藻等。

紫外光殺菌之優點

1. 可以殺死空氣中懸浮之細菌或病毒。
2. 細菌或病毒不會有抗藥性。
3. 紫外線不會殘留。
4. 不會有吸入性之傷害。
5. 不會造成環境污染。

產品特色

1. 閃光警示燈：紫外光是「不可見光」，人類的眼晴看不到。本產品加裝閃光警示燈，警示紫外線燈管已經在運作，人員不可進入紫外光照射範圍內，以免受到傷害。
2. 遙控器：使用者可在紫外光照射範圍以外操作，安全有保障。
3. UVC 紫外線殺菌燈管：使用四支 20W UVC 紫外線殺菌燈管，燈光夠強，殺菌能力強，能在短時間內殺死細菌病毒。
4. 不鏽鋼保護網：可以保護燈管，避免燈管被碰觸而導致破裂。

5. 把手與輪子：方便本產品之移動，不須用手提的。
6. 底座：底座高與大，穩重不會摔倒，安全穩固。
7. 電子式安定器：台灣製造電子式安定器，通過國家安規認證，品質優良。
8. 燈管高度：燈管裝置之高度，介於桌面上下之間，桌面上方與下方皆可照射到，殺菌的範圍大。燈管使用 4 支燈管，分別裝置於四面，前後左右四面皆可照射殺菌。

適用場所

1. 學校或幼兒園教室、辦公室等。
2. 飯店、民宿、餐廳、KTV 廂房等。
3. 醫院病房、療養院、診所。
4. 賣場、超市、會場等。
5. 其它室內空間。

殺菌試驗

本產品經送往日本東京「ウイルス除菌研究所多摩支社」做試驗，證實確可殺死「COVID-19 新型冠狀病毒」與「流感病毒」，且無化學物質之降解性，不會對物體造成破壞。

產品規格

型號：GL-204A-58

殺菌燈管：G20T8，20W X 4

燈管長度：58cm，台灣規格

紫外光波長：253.7 nm

安定器：電子式安定器

額定電壓：110V-220V 全電壓

額定功率：91W

外殼材料：磨光鋼板白色烤漆

外殼尺寸：130cm x 43cm x 40cm

生產地：台灣

UVC紫外線殺菌器

輕鋼架型



加裝：



+



**閃光警示燈+定時器
安全多重保護**

使用UVC紫外線殺菌燈管與電子式安定器

LED一體線型燈

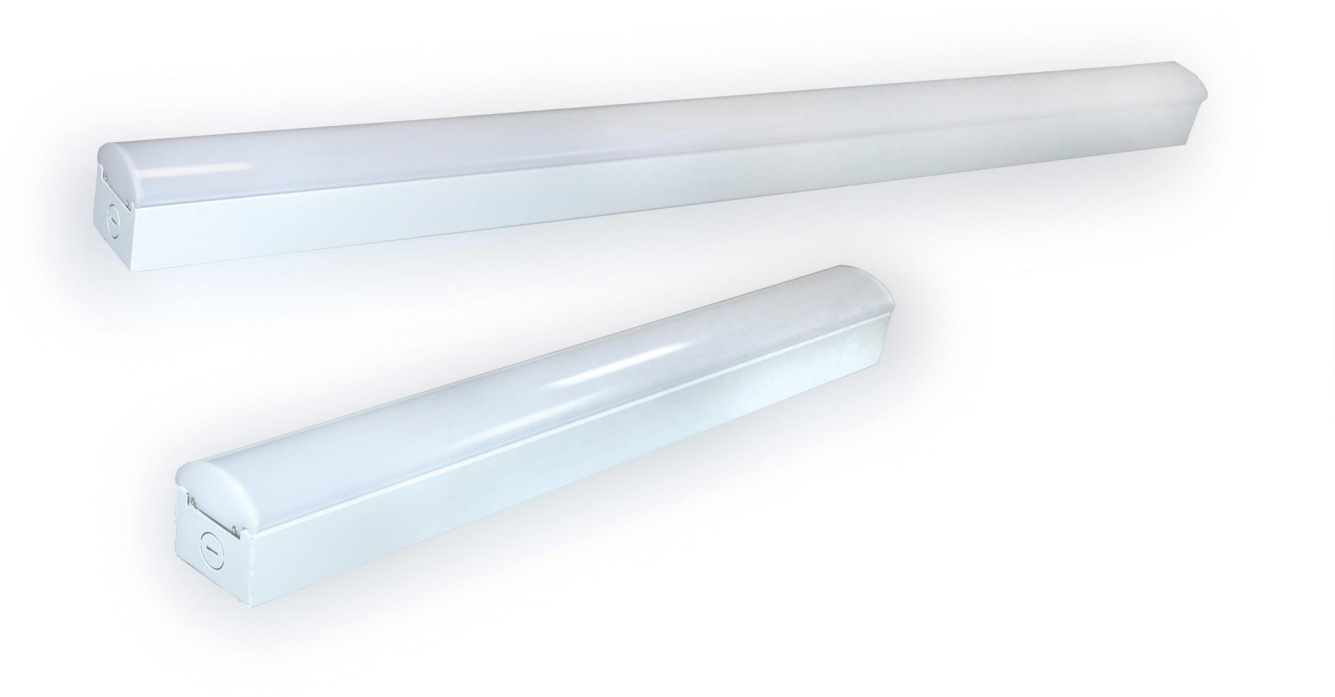

- ◆ 日規款式。
- ◆ 直下式光源，不需折射與反射，燈光不折損。相較於管型燈管，燈光 360 度漫射，需要折射與反射才能下照，折損燈光。
- ◆ 燈體發光面積大，降低眩光，保護眼睛。
- ◆ 備有 2 尺與 4 尺規格。

型號 Model No.	光源 Light Source	功率 Wattage	輸入電壓 Input Voltage	主體尺寸 Size (mm)		
				長(L)	寬(W)	高(H)
HCJ-102	LED	20W	AC 100V - 277V	578	64	64
HCJ-104	LED	40W	AC 100V - 277V	1218	64	64



LED 軟條燈

LED SOFT STRIP LIGHT

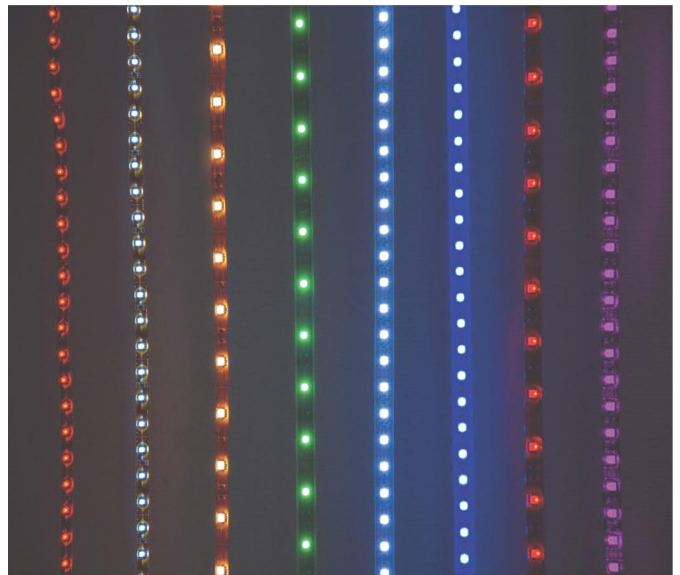
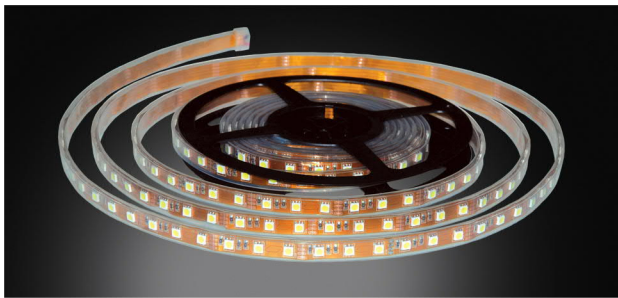

- ◇ LED 規格：SMD5050。
- ◇ LED 間距：每公尺 60 顆。
- ◇ 長度：1m ~ 5m，每捲 5m。
- ◇ 光色：白光、黃光、紅光、綠光、藍光、紅綠藍變色。
- ◇ 用途：(1). 裝飾用，(2). 作為層板燈用。
- ◇ LED No.：SMD5050.
- ◇ LED Interval: 60 pcs per meter.
- ◇ Length：5 meters per roll.
- ◇ Light Color：white、yellow、red、green、blue、RGB rotating.
- ◇ Purposes：(1) Decoration, (2) Indirection Lighting.

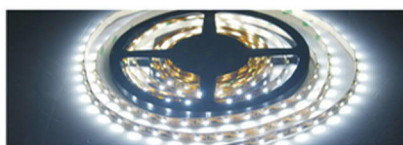
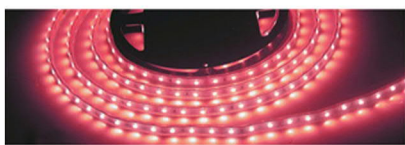
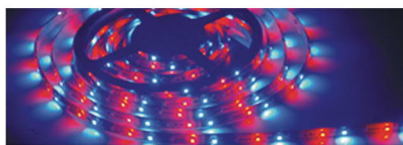
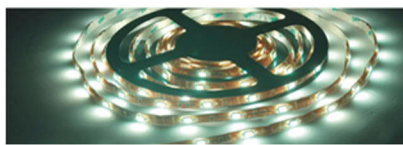

產品型號 MODLE NO.	LED 類型 LED TYPE	燈條封裝 STRIP PACKAGE	長度 LENGTH	LED 數量 LED QUANTITY	顏色 COLOR	波長色溫 WEAVE LENGTH	出光角度 BEAM ANGLE	電壓 VOLT
LE-F5050-61B	SMD5050	裸板 Bare Board	5 m	300 pcs , 60 pcs/m	Red	625nm	120	12V DC
LE-F5050-62B	SMD5050	裸板 Bare Board	5 m	300 pcs , 60 pcs/m	Yellow	590nm	120	12V DC
LE-F5050-63B	SMD5050	裸板 Bare Board	5 m	300 pcs , 60 pcs/m	Blue	470nm	120	12V DC
LE-F5050-64B	SMD5050	裸板 Bare Board	5 m	300 pcs , 60 pcs/m	Green	515nm	120	12V DC
LE-F5050-65B	SMD5050	裸板 Bare Board	5 m	300 pcs , 60 pcs/m	Warm White	4000K	120	12V DC
LE-F5050-66B	SMD5050	裸板 Bare Board	5 m	300 pcs , 60 pcs/m	Cool White	6500K	120	12V DC
LE-F5050-67B	SMD5050RGB	裸板 Bare Board	5 m	300 pcs , 60 pcs/m	RGB Colors	RGB Colors	120	12V DC
LE-F5050-61S	SMD5050	套管 Sleeve	5 m	300 pcs , 60 pcs/m	Red	625nm	120	12V DC
LE-F5050-62S	SMD5050	套管 Sleeve	5 m	300 pcs , 60 pcs/m	Yellow	590nm	120	12V DC
LE-F5050-63S	SMD5050	套管 Sleeve	5 m	300 pcs , 60 pcs/m	Blue	470nm	120	12V DC
LE-F5050-64S	SMD5050	套管 Sleeve	5 m	300 pcs , 60 pcs/m	Green	515nm	120	12V DC
LE-F5050-65S	SMD5050	套管 Sleeve	5 m	300 pcs , 60 pcs/m	Warm White	4000K	120	12V DC
LE-F5050-66S	SMD5050	套管 Sleeve	5 m	300 pcs , 60 pcs/m	Cool White	6500K	120	12V DC
LE-F5050-67S	SMD5050RGB	套管 Sleeve	5 m	300 pcs , 60 pcs/m	RGB Colors	RGB Colors	120	12V DC

燈光設計 照明規劃

